

**OXFORD MAYOR AND COUNCIL  
REGULAR MEETING  
TUESDAY, October 4, 2021 – 7:00 PM  
VIA TELECONFERENCE  
A G E N D A**

1. Call to Order, Mayor David S. Eady.
2. Invocation.
3. Motion to accept the Agenda for the October 4, 2021 Mayor and Council Regular Meeting.
4. **CONSENT AGENDA**
  - a. \* Regular Session Meeting September 7, 2021
  - b. \* Minutes of the Special Called Meeting September 20, 2021
  - c. \* Minutes of the Work Session September 20, 2021
  - d. \* Planning Commission Meeting July 13, 2021
  - e. \* Trees, Parks, and Recreation Board Meeting July 13, 2021
  - f. \* Minutes of the Downtown Development Authority Meeting August 24, 2021.
5. Mayor's Announcements.
6. Planning Commission Recommendations/Petitions.
7. Citizen Concerns.
8. **\*MEAG Power Resolution for Municipal Competitive Trust Fund** – The City of Oxford identifies two independent City officials by resolution to communicate decisions of the City regarding its Municipal Competitive Trust Fund. In 2020, Mayor David Eady and City Manager Matthew Pepper were identified as the two City officials. Since Matthew Pepper is no longer employed with the City of Oxford, the resolution must be updated. In consultation with MEAG, the City proposes replacing specific names on this document with titles so that it does not require updating each time the person in the position changes. The proposed resolution is attached.
9. **\*MEAG 2022 Capacity Needs** – The City of Oxford has been advised by MEAG that it has a capacity shortage for 2022 of 907 kw (484 kw Reserve and 485 kw Supplemental). Details regarding this shortage are attached. The City has asked MEAG to prepare the documents to complete the purchase of reserve and supplemental capacity from the City of Elberton.
10. **\*Oxford Police Department Body Camera Storage Process** – The Oxford Police Department currently stores body camera footage on external hard drives. The current upload process for the footage is time consuming and cumbersome, and speed of upload is contingent upon an officer being available to perform the process. The Police Department has received a proposal from the vendor of their cameras for a 60-month agreement to provide cloud storage for body camera footage. The storage process is proprietary to the brand of cameras and using a different storage service would require

purchase of new cameras. Therefore, competitive bids cannot be obtained for this service without replacement of the cameras, which is not necessary at this time. Installation costs are \$1,563.00 and there is a recurring annual cost of \$1,392.00 for 60 months. Chief Harvey recommends approval of the contract.

11. **\*Purchase of 47' Derrick Truck for Public Works Department** – The FY 2021 Capital Budget includes funds for replacement of the Public Works' derrick truck. Bids were received from two vendors. Availability of vendors for this product is very limited. Staff recommends awarding the contract for this equipment to Altec, the low bidder, for \$207,290. Delivery of the truck will take approximately one year, so the order needs to be placed since there are already mechanical problems with the current equipment.
12. **\*Replacement of Gutter Guards at City Hall** – It was recently discovered that the gutter guards installed on the City Hall building when it was built are rotten and need to be replaced. Three bids were obtained for performance of this work. Staff recommends awarding the contract to the low bidder, KJGR, LLC, for \$5,400.00 to complete this work. The three bids are attached.
13. **\*City of Oxford State Fiscal Recovery Fund Application** – Authorization for the Mayor to send a letter (see attached) to the Northeast Georgia Regional Commission for the preparation of an application to supplement the water line replacement work recently funded by the FY 2021 CDBG award. The cost for the application will be \$500 and it is due to the State by October 31. The submittal of the application will be voted on in a Special Called meeting with the October 18 Work Session.
14. **\*Invoices** – Council will review the city's recently paid invoices over \$1,000.
15. **Executive Session.**
16. Adjourn.

\*Attachments

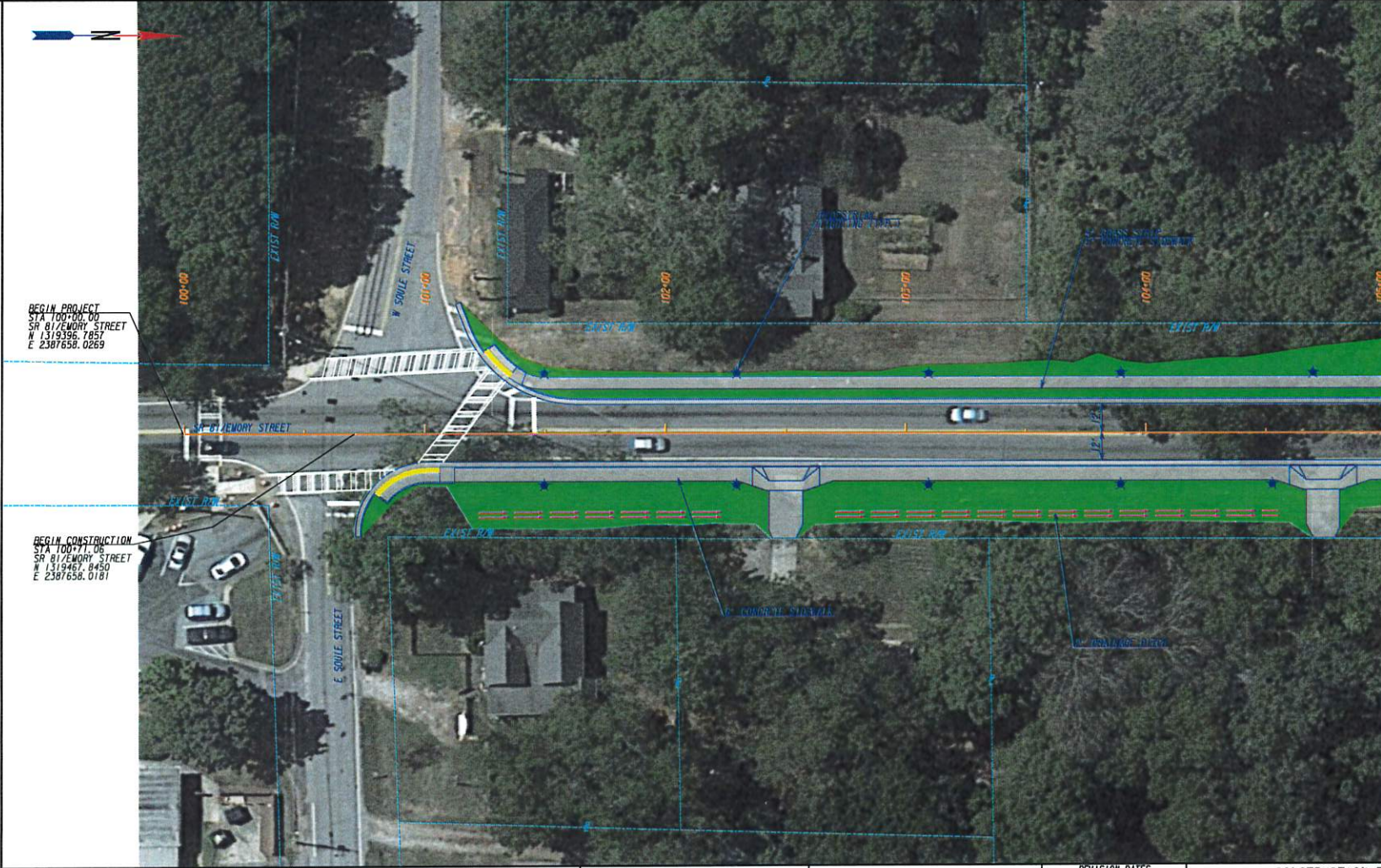

BEGIN PROJECT  
STA 100+00.00  
SR 81/EMORY STREET  
N 1319396.7857  
E 2387658.0269

BEGIN CONSTRUCTION  
STA 100+77.00  
SR 81/EMORY STREET  
N 1319467.8450  
E 2387658.0181

MATCHLINE - STA 105+00.00  
SEE DWG. 13-0002

PROPERTY AND EXISTING R/W LINE  
REQUIRED R/W LINE  
CONSTRUCTION LIMITS  
EASEMENT FOR CONSTR  
& MAINTENANCE OF SLOPES  
EASEMENT FOR CONSTR OF SLOPES  
EASEMENT FOR CONSTR OF DRIVES

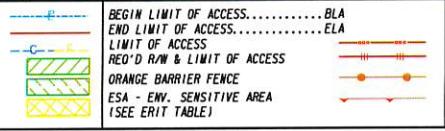

**Keck+Wood**  
COLLABORATION BY DESIGN  
4899 Prosperity Parkway, Suite 400  
Duluth, GA 30097  
(878) 417-4050 keckwood.com



REVISION DATES	

**CONSTRUCTION PLAN**  
SR 81/EMORY STREET  
NEWTON COUNTY

CHECKED:	DATE:	DRAWING NO. <b>13-0001</b>
BACKCHECKED:	DATE:	
CORRECTED:	DATE:	
VERIFIED:	DATE:	



MATCHLINE - STA 105+00.00  
SEE DWG. 13-0001

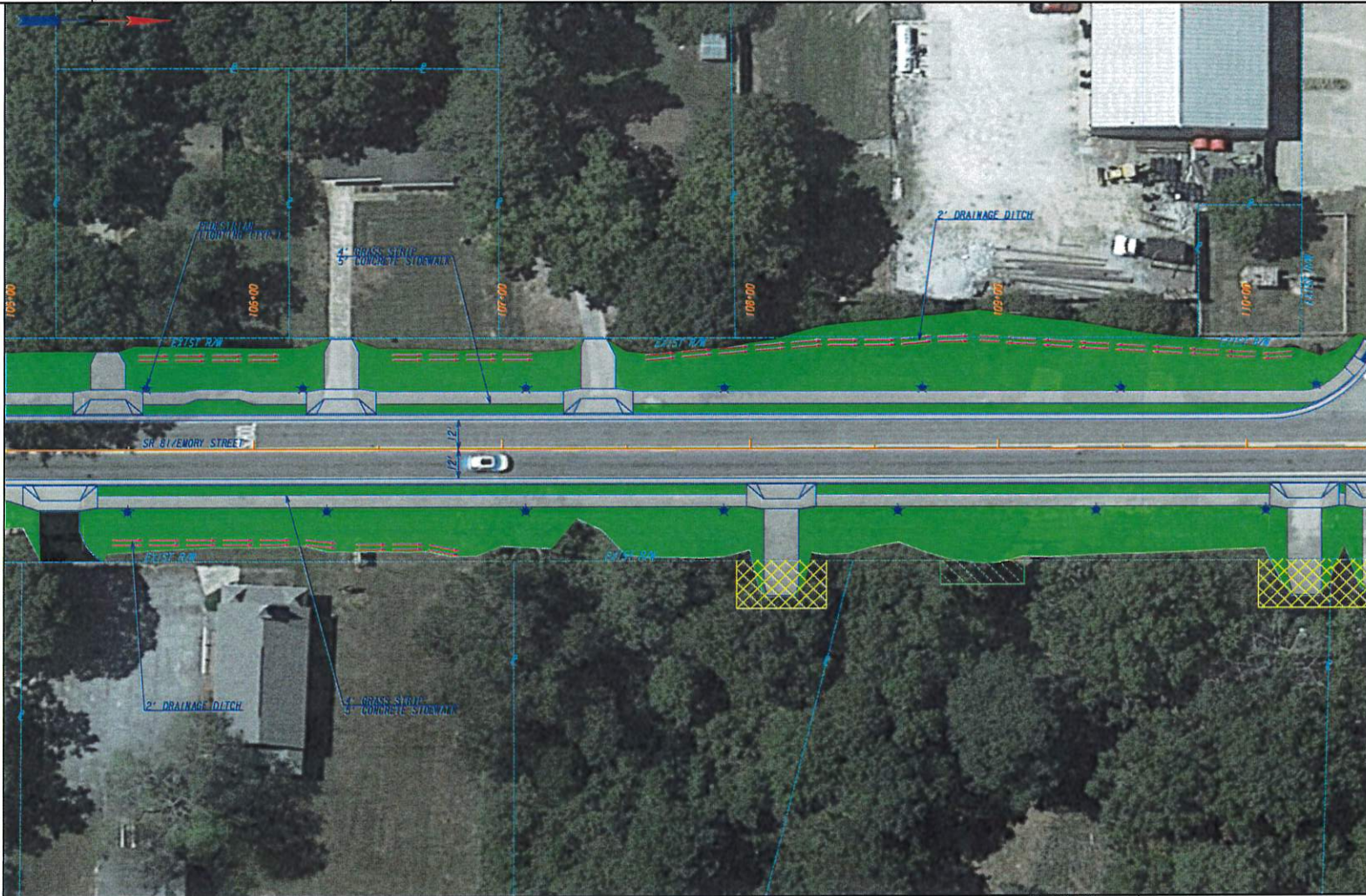

MATCHLINE - STA 110+50.00  
SEE DWG. 13-0003

PROPERTY AND EXISTING R/W LINE  
REQUIRED R/W LINE  
CONSTRUCTION LIMITS  
EASEMENT FOR CONSTR  
& MAINTENANCE OF SLOPES  
EASEMENT FOR CONSTR OF SLOPES  
EASEMENT FOR CONSTR OF DRIVES

- BEGIN LIMIT OF ACCESS.....BLA
- END LIMIT OF ACCESS.....ELA
- LIMIT OF ACCESS
- REQ'D R/W & LIMIT OF ACCESS
- ORANGE BARRIER FENCE
- ESA - ENV. SENSITIVE AREA (SEE ERIT TABLE)

**Keck+Wood**  
COLLABORATION BY DESIGN  
4095 Piedmont Parkway, Suite 250  
Duluth, GA 30097  
404.271.4699 keckwood.com



REVISION DATES	

**CONSTRUCTION PLAN**  
SR 81/EMORY STREET  
NEWTON COUNTY

CHECKED:	DATE:	DRAWING No. <b>13-0002</b>
RECHECKED:	DATE:	
CORRECTED:	DATE:	
VERIFIED:	DATE:	



MATCHLINE - STA 110+50.00  
SEE DWG. 13-0002



MATCHLINE - STA 116+00.00  
SEE DWG. 13-0004

PROPERTY AND EXISTING R/W LINE  
REQUIRED R/W LINE  
CONSTRUCTION LIMITS  
EASEMENT FOR CONSTR  
& MAINTENANCE OF SLOPES  
EASEMENT FOR CONSTR OF SLOPES  
EASEMENT FOR CONSTR OF DRIVES

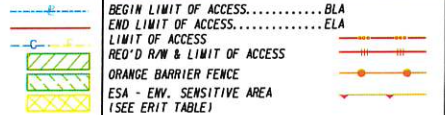

**Keck+Wood**  
COLLABORATION BY DESIGN  
3030 Phipps Parkway, Suite 200  
Duluth, GA 30017  
(978) 817-4020 keckwood.com

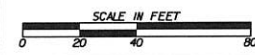

REVISION DATES	

<b>CONSTRUCTION PLAN</b> SR 81/EMORY STREET NEWTON COUNTY		DRAWING NO.
		13-0003
CHECKED:	DATE:	
DESIGNED:	DATE:	
VERIFIED:	DATE:	



MATCHLINE- STA 116+00.00  
SEE DWG. 13-0003

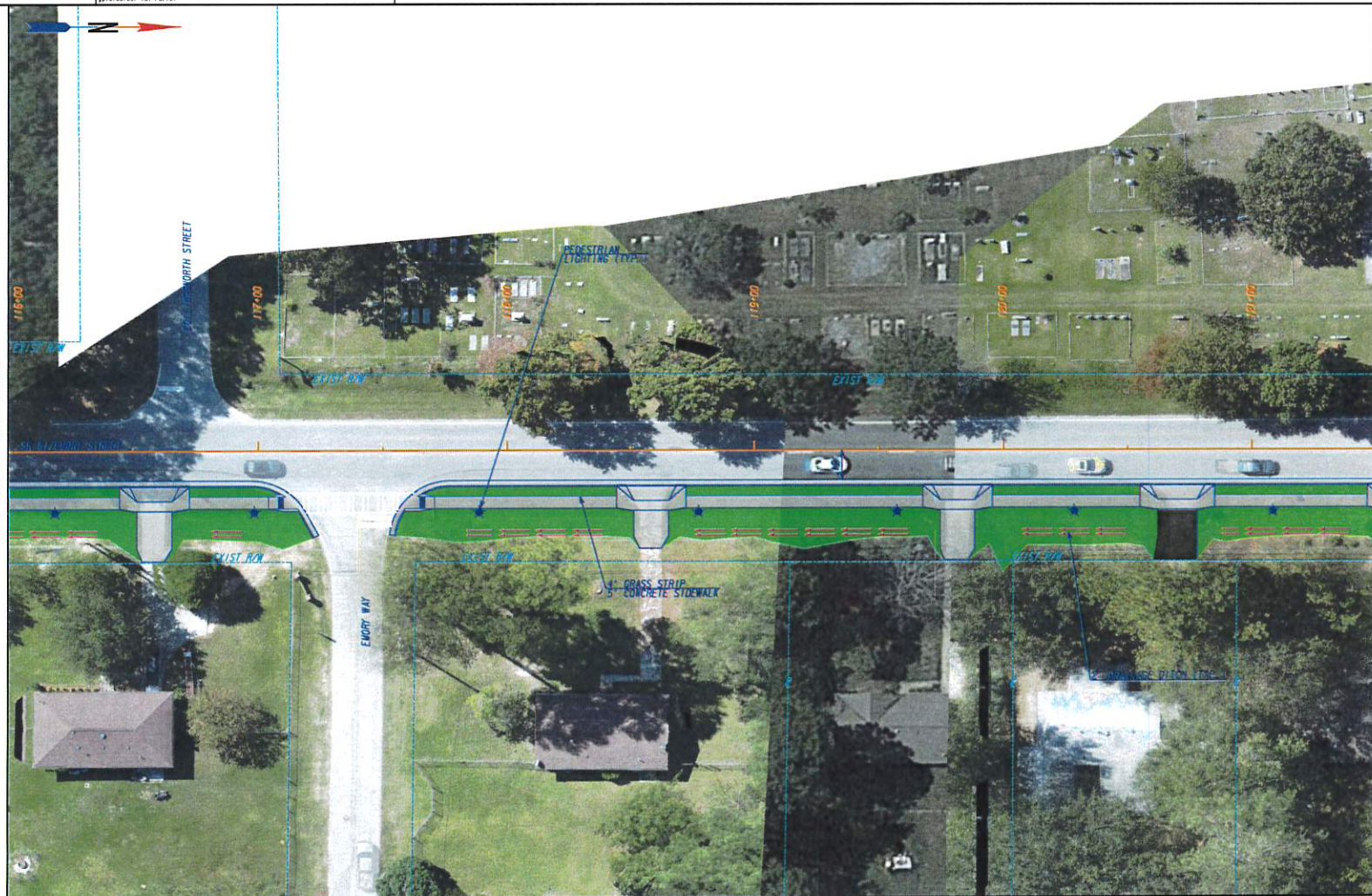

MATCHLINE- STA 121+50.00  
SEE DWG. 13-0005

PROPERTY AND EXISTING R/W LINE  
REQUIRED R/W LINE  
CONSTRUCTION LIMITS  
EASEMENT FOR CONSTR  
& MAINTENANCE OF SLOPES  
EASEMENT FOR CONSTR OF SLOPES  
EASEMENT FOR CONSTR OF DRIVES

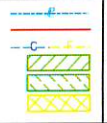

BEGIN LIMIT OF ACCESS.....BLA  
END LIMIT OF ACCESS.....ELA  
LIMIT OF ACCESS.....LA  
RED'D R/W & LIMIT OF ACCESS  
ORANGE BARRIER FENCE  
ESA - ENV. SENSITIVE AREA  
(SEE ERIT TABLE)

**keck+Wood**  
COLLABORATION BY DESIGN  
3033 Piedmont Parkway, Suite 200  
Duluth, GA 30097  
(878) 417-4000 keckwood.com

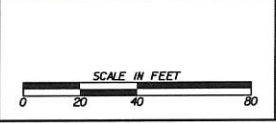

REVISION DATES	

**CONSTRUCTION PLAN**  
SR 81/EMORY STREET  
NEWTON COUNTY

CHECKED:	DATE:	DRAWING NO.
DESIGNED:	DATE:	13-0004
CONVERTED:	DATE:	
VERIFIED:	DATE:	



MATCHLINE- STA 121+50.00  
SEE DWG. 13-0004



PROPERTY AND EXISTING R/W LINE  
REQUIRED R/W LINE  
CONSTRUCTION LIMITS  
EASEMENT FOR CONSTR  
& MAINTENANCE OF SLOPES  
EASEMENT FOR CONSTR OF SLOPES  
EASEMENT FOR CONSTR OF DRIVES

	BEGIN LIMIT OF ACCESS.....BLA
	END LIMIT OF ACCESS.....ELA
	LIMIT OF ACCESS
	RED'D R/W & LIMIT OF ACCESS
	ORANGE BARRIER FENCE
	ESA - ENV. SENSITIVE AREA (SEE ERIT TABLE)

**Keck+Wood**  
COLLABORATION BY DESIGN  
8099 Promera Parkway, Suite 250  
Duluth, GA 30097  
(478) 917-4009 keckwood.com

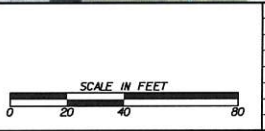

REVISION DATES

**CONSTRUCTION PLAN**  
SR 81/EMORY STREET  
NEWTON COUNTY

CHECKED:	DATE:	DRAWING NO.
BACKCHECKED:	DATE:	13-0005
CONSTRUCTED:	DATE:	
VERIFIED:	DATE:	



**DRAFT MINUTES OF THE OXFORD MAYOR AND COUNCIL MEETING  
REGULAR SESSION  
MONDAY, SEPTEMBER 7, 2021 – 7:00 PM  
Via Teleconference  
DRAFT**

**ELECTED OFFICIALS PRESENT:**

David Eady – Mayor  
George Holt – Councilmember  
Jim Windham – Councilmember  
Lynn Bohanan – Councilmember  
Jeff Wearing – Councilmember  
Laura McCanless – Councilmember  
Avis Williams - Councilmember

**APPOINTED/STAFF PRESENT:**

Bill Andrew – City Manager  
Marcia Brooks – City Clerk/Treasurer  
Dave Harvey – Chief of Police  
C. David Strickland – City Attorney

**OTHERS PRESENT:** Rev. Virginia Brown (Rust Chapel United Methodist Church), Mike Ready

1. The meeting was called to order by the Hon. David Eady, Mayor.
2. Invocation – Rev. Virginia Brown, Rust Chapel United Methodist Church.
3. Mayor Eady clarified that separate votes will be taken for consideration to add two holidays to list of official City holidays in Item #10.

**Avis Williams made a motion to accept the Agenda for September 7, 2021. Jim Windham seconded the motion. The motion was approved unanimously (7/0).**  
(Attachment A)

4. **Avis Williams made a motion to accept the Consent Agenda for September 7, 2021. Avis Williams seconded the motion. The motion was approved unanimously (7/0).**  
(Attachment B)

5. Mayor's Announcements  
Mayor Eady introduced the new City Manager, Bill Eady.

Mayor Eady stated that he recommends the City Council continue to meet remotely because of the high COVID-19 numbers in Newton County. The City Councilmembers were comfortable with this recommendation.



Mayor Eady announced a City Council mini-retreat scheduled for October 29, 2021. The session will include updates from the Municipal Electric Authority of Georgia (MEAG), Newton County Water and Sewer Authority (NCWSA), and Dean Hicks at Oxford College. The agenda will also include a review of the City's Short Term Work Program as well as some preliminary preparation for a strategic planning engagement with the UGA Carl Vinson Institute of Government (CVIOG). He will be bringing a proposal from CVIOG to the City Council to decide if they want to engage them in this process.

He is also discussing a classification/compensation study with CVIOG to examine the job classifications the City currently has and benchmarking them against other cities. This study will provide an analytical basis for reevaluating the City's classification structure and pay scale. The cost will be in the range of \$6,000-\$12,000, and probably closer to \$6,000. He will also bring this proposal to the City Council when it is available.

6. **Planning Commission Recommendations/Petitions**

None.

7. **Citizen Concerns**

None.

8. **Adoption of 2021 Millage Rate** (Attachment C)

Rollback of the millage rate for 2021 to 5.444 has been discussed by the City Council in order to avoid a property tax increase in 2021 for Oxford residents.

**George Holt made a motion to adopt the rollback rate of 5.444 for 2021 for the City of Oxford. Jeff Wearing seconded the motion. The motion was approved unanimously (7/0).**

9. **Tax Collection Intergovernmental Agreement** (Attachment D)

The City of Oxford has discussed a new agreement for the Newton County Tax Commissioner to prepare the Oxford tax digest and to levy, assess, and collect property taxes. Execution of a new agreement is required because a new Tax Commissioner was elected for Newton County in 2020. Other than the Commissioner being a different person, the terms of the contract are the same as in previous years.

**Jeff Wearing made a motion to approve the Tax Collection Intergovernmental Agreement. George Holt seconded the motion. The motion was approved unanimously (7/0).**

10. **Official City Holidays** (Attachment E)

The City Council has discussed a proposed resolution adding two holidays to the list of official City holidays: Veterans' Day (November 11<sup>th</sup>) and Juneteenth (June 19<sup>th</sup>).

**Laura McCanless made a motion to add Veterans' Day to the list of official city holidays. Jeff Wearing seconded the motion.**

**Discussion:**

Jim Windham stated he asked another Councilmember what the rationale was for adding Veterans' Day and was advised that it is because it is a federal holiday. He stated there are two other federal holidays not recognized by the City of Oxford, i.e., Columbus Day and President's Day. The City has the same number of holidays as the federal government, but recognizes two that the federal government does not, i.e., the day after Thanksgiving and Christmas Eve. He recommends that the City create a holiday whenever there is a federal or state election. He feels doing so is a better way of honoring the country's veterans and its democracy. Voting is becoming increasingly problematic, and he does not expect it to ease up any time soon.

Avis Williams stated she understands what Mr. Windham is saying but she does not have any problem with giving City employees Veterans' Day off.

George Holt stated he thinks Mr. Windham has a valid point. In speaking with Matt Pepper about this issue he was initially concerned about allowing more holidays since the City already allowed the same number of holidays as the federal government. He was not in favor of giving the City more holidays, but also did not want to vote against it.

Laura McCanless likes the idea of making election day a priority. She just does not want to see the employees get cheated out of a holiday in a non-election year. She likes the idea of giving employees another day off, since most of them must work on July 4<sup>th</sup> to support the annual parade activities.

Lynn Bohanan stated her thoughts are in line with those of Ms. McCanless.

Jeff Wearing voiced objection to not observing Veterans' Day. He understands Mr. Windham's point but disagrees with a holiday for Election Day being approved in lieu of Veterans' Day.

Marcia Brooks stated that in addition to comparing the City's list of holidays to the federal holidays, thought was also given to ways the City can attract and retain employees. A review of the surrounding counties and municipalities that Oxford regularly loses employees to revealed that these jurisdictions are observing the two proposed holidays.

Ms. McCanless asked how many personnel are needed on hand to handle an election. Ms. Brooks advised that she is the election superintendent so she would be the person handling this. Ms. McCanless also stated that she respects Mr. Wearing's position.

**The motion carried by a majority vote (6/1) with Jim Windham voting Nay.**

**Jim Windham made a motion to add Juneteenth to the list of official City holidays. George Holt seconded the motion. The motion was approved unanimously (7/0).**



Mayor Eady stated that the topic of Election Day as a City holiday can be added to a work session agenda. Providing opportunities for employees to vote can also be handled very liberally from an administrative perspective to ensure all employees have the opportunity.

11. **Employee Handbook** (Attachment F)

The Council has discussed proposed revisions to the City of Oxford Employee Handbook. No comments have been received since the matter was last discussed at the August work session.

George Holt stated that he has had a few calls since the last meeting. He feels that more time is needed to look over the information given the volume of information they must absorb. He recommended that they spend some time discussing the changes at the upcoming mini-retreat.

**George Holt made a motion to table discussion of the Employee Handbook. Jim Windham seconded the motion. The motion was approved unanimously (7/0).**

12. **Alarm Monitoring Services** (Attachment G)

Due to dissatisfaction with the City's current alarm monitoring service, staff obtained quotes from three alarm monitoring companies to provide monitoring services for City Hall and the Maintenance Facility. Staff recommends awarding the contract to All-Star Alarms, which provided the lowest bid.

**Laura McCanless made a motion to award the contract for alarm monitoring services to All-Star Alarms. George Holt seconded the motion.**

Discussion:

Jeff Wearing advised the Mayor and City Council that he believes All-Star Alarms is not the best selection because the owners are wanting to sell the business. This could lead to problems with service in the future. He believes Viper is the better choice even though their price is slightly higher. They serve all of Newton County government's buildings and he believes they will give better service. He also spoke to Sheriff Ezell Brown who gave them a high recommendation and indicated they were the best company the Sheriff's Office ever had.

Jim Windham and Avis Williams asked if references for the three vendors could be checked.

Marcia Brooks let the Mayor and City Council know that the current contract has already been canceled and expires on 9/30/2021, so action needs to be taken expeditiously.

George Holt suggested that since the normal procedure is to accept the recommendation of staff, that the City Manager be allowed to further investigate and see if he wants to amend staff's recommendation.

**Laura McCanless and George Holt withdrew their motion and second.**

**Jim Windham made a motion to table a decision on the alarm monitoring services contract until the September work session. George Holt seconded the motion.**

Discussion:

Marcia Brooks asked if tabling the decision would allow enough time to avoid a lapse in security monitoring. Mayor Eady stated a called session could be held at the start of the work session to take a vote.

The motion was approved unanimously (7/0).

13. **Approval for Purchase of Lawnmower** (Attachment H)

The Public Works Department requests approval to purchase a lawnmower which was authorized in the FY2022 Capital Budget. Three bids have been obtained. The Public Works Department has ordered the mower from Monroe Power Equipment due to the long lead time required to get the equipment. Staff recommends approval of the purchase of the equipment from Monroe Power Equipment for \$10,941.

**Jim Windham made a motion to approve purchase of the lawnmower from Monroe Power Equipment. Jeff Wearing seconded the motion. The motion carried unanimously (7/0).**

14. **Approval for Purchase of Police Car**

The Police Department requests approval to purchase a police car which was authorized in the FY2022 Capital Budget. The City of Oxford is authorized to utilize \$100,000 in 2017 SPLOST funds for public safety purposes. Three bids have been obtained for a Ford Explorer Hybrid. Mayor Eady stated that the recommendation is to purchase the vehicle from the lowest bidder, Wade Ford, for \$36,095.

**George Holt made a motion to approve the purchase of a police car from Wade Ford. Laura McCanless seconded the motion.**

Discussion:

Chief Dave Harvey stated that arrangements have already been made with Allan Vigil Ford to purchase the vehicle from them. Bill Andrew added that the 2021 model is no longer available, but Allan Vigil Ford will deliver the 2022 model for the same price previously quoted for the 2021 model.

**George Holt amended his motion to approve the purchase of a police car from Allan Vigil Ford. Laura McCanless amended her second likewise. The motion was approved unanimously (7/0).**

15. **Invoices**

Mayor Eady stated that he is having discussions with Marcia Brooks and Bill Andrew about revising this part of the agenda to be a brief financial report that will provide more useful information. The list of invoices will still be provided to the City Council for review.

16. **Executive Session**

None.

17. **Adjourn**

**Jim Windham made a motion to adjourn at 7:47 p.m. Jeff Wearing seconded the motion. The motion was approved unanimously (7/0).**

Respectfully Submitted,

Marcia Brooks  
City Clerk/Treasurer





**DRAFT MINUTES OF THE OXFORD MAYOR AND COUNCIL MEETING  
SPECIAL CALLED MEETING  
MONDAY, SEPTEMBER 20, 2021 – 6:30 PM  
VIA TELECONFERENCE  
DRAFT**

**ELECTED OFFICIALS PRESENT:**

David Eady – Mayor  
George Holt – Councilmember  
Lynn Bohanan – Councilmember  
Avis Williams – Councilmember  
Laura McCanless – Councilmember  
James Windham – Councilmember  
Jeff Wearing – Councilmember

**APPOINTED/STAFF PRESENT:**

Bill Andrew – City Manager  
Marcia Brooks – City Clerk/Treasurer  
Jody Reid – Utilities/Maintenance  
Supervisor  
Dave Harvey – Police Chief

**OTHERS PRESENT:** Art Vinson, Cheryl Ready, Michael Ready, Melissa Hage, Robert Renwick (Keck & Wood)

1. The meeting was called to order by the Hon. David Eady, Mayor.
2. **A motion was made by Laura McCanless to accept the Agenda for the Special Called Meeting of September 20, 2021. Lynn Bohanan seconded the motion. The motion was approved unanimously (7/0).** (Attachment A)
3. **Alarm Monitoring Services** (Attachment B)  
Staff has recommended hiring a new company to provide alarm monitoring services to City Hall and the Maintenance Facility due to dissatisfaction with current services provided. City Manager Bill Andrew has contacted references for the three companies and based on those references and the responsiveness of Viper Security Technologies, he recommends awarding the contract to them.  
**Jim Windham made a motion to award the contract for security monitoring services to Viper Security Technologies. Laura McCanless seconded the motion. The motion was approved unanimously (7/0).**
4. Adjourn  
**Jim Windham made a motion to adjourn the Special Called Meeting at 6:35 p.m. Lynn Bohanan seconded the motion. The motion was approved unanimously (7/0).**

Respectfully Submitted,

Marcia Brooks  
City Clerk/Treasurer



**DRAFT MINUTES OF THE OXFORD MAYOR AND COUNCIL MEETING  
WORK SESSION  
MONDAY, SEPTEMBER 20, 2021 – 6:35 PM  
VIA TELECONFERENCE  
DRAFT**

**ELECTED OFFICIALS PRESENT:**

David Eady – Mayor  
George Holt – Councilmember  
Jim Windham – Councilmember  
Lynn Bohanan – Councilmember  
Laura McCanless – Councilmember  
Avis Williams – Councilmember  
Jeff Wearing – Councilmember

**STAFF PRESENT:**

Marcia Brooks – City Clerk/Treasurer  
Bill Andrew – City Manager  
Dave Harvey – Chief of Police  
Jody Reid – Utilities/Maintenance  
Supervisor

**OTHERS PRESENT:** Art Vinson, Mike Ready, Cheryl Ready, Robert Renwick (Keck & Wood)

**Agenda** (Attachment A)

**1. Mayor's Announcements**

Mayor Eady did not have any announcements.

**2. Committee Reports**

**a. Trees, Parks, and Recreation Board**

Cheryl Ready stated that the board is asking residents if they are interested in participating in the free giveaway of trees to revitalize the tree canopy on Emory Street.

Laura McCanless added that she and Theresa Eady are also collecting bids from providers in Atlanta that will remove invasive species from land in a sensitive manner without heavy chemical use. When they receive one final bid, they will formulate a proposal to present to the City Council.

Mayor Eady asked Ms. McCanless if they had checked into the Chew Crew. She advised they had not obtained a bid from them. The information she has gotten concerning goat and sheep clean-up is that they eat everything, including the beneficial plants and small trees. They want to avoid depleting the beneficial items if possible. Also, the invasive plant species will come right back.

- b. Planning Commission – Mike Ready stated that the Planning Commission plans to discuss the final draft of the ordinance amendments they had recommended at their next meeting.
- c. Downtown Development Authority (DDA) – Mike Ready stated that they will be looking at some quotes for making improvements to the greenspace at their next meeting.
- d. Sustainability Committee – Laura McCanless reported the committee is doing some research on recycling alternatives with the goal of decreasing the overall carbon footprint.
- e. Committee on Race – Avis Williams reported that the committee members are participating in the symposium presented by Emory next week. She will forward the link to register to the City Councilmembers.
- f. Cemetery Committee – Lynn Bohanan stated that Anderson Wright has two proposals for care of the cemetery. She advised that the Schneiders are not interested in rebidding. Mayor Eady stated that the bids he has are ones that were obtained by Matt Pepper earlier this year, and probably need to be refreshed. The recommendation is to let the current contract run out in December 2021 and start with the new contract in January 2022.

### 3. **Emory Street Sidewalk Improvements** (Attachment B)

The City of Oxford plans to add sidewalks and a mid-block crossing with a rapid-flashing beacon on the north side of the City along Highway 81/Emory Street. Robert Renwick from Keck & Wood has worked on draft construction drawings for this project. He presented an overview of the construction drawings.

The project also includes pedestrian lighting. Mr. Renwick recommends that the lighting used on this project become a standard for lighting throughout the City. Mayor Eady stated that one desired goal with the lighting is that light spillage beyond the pedestrian area would be minimized. He also mentioned that the City's lighting should be distinctive from the lighting on the Oxford College campus. The Oxford College lighting is also taller than the lighting desired for this project. Mayor Eady asked Mr. Renwick to provide some recommendations for the City Council to select from.

Laura McCanless asked if there are options for how long the lighting stays on. Specifically, is it motion sensitive, or does it come on at a certain time and stay on? Ideally, it would be motion-sensitive rather than staying on all night to minimize disturbance to wildlife and reduce energy usage and would not be triggered by vehicle traffic – only by pedestrian traffic. Mr. Renwick advised he would investigate the options available and include that information in the design drawings.

Ms. McCanless and Lynn Bohanan asked why the crossing is oriented in the middle of the block and not closer to the cemetery and park. Mr. Renwick explained that the crossing is placed where it is to connect with an existing trail leading to the park, and that placement of the crossing further south would require a bridge to cross over a swampy area to get to the park. He also stated that when a highway does not have a stop control at an intersection, it

is preferred to move the crossing away from that intersection (Collingsworth Street/Emory Way) so that drivers have time to turn onto the highway and make visual contact with the flashing beacons and the pedestrians in the crossing.

Lynn Bohanan stated she is unsure about having the crossing come into a wooded area. Mayor Eady stated the current plan would result in minimal disturbance to the land.

Jim Windham asked for clarification on the statement about the intersection. He expressed concern that engineering efforts are being channeled toward accommodating vehicles instead of accommodating pedestrians. He feels that children who want to cross will do it closer to Emory Way rather than walk to the crossing that is planned for mid-block.

Mr. Renwick disagreed that placing the crossing mid-block is accommodating vehicles. He reiterated that this placement is safer for pedestrians because it allows drivers more time to see pedestrians crossing after they turn onto Highway 81. He also indicated that he doubts if the Georgia Department of Transportation (GDOT) would approve the crossing closer to Emory Way/Collingsworth Street.

Lynn Bohanan stated that when drivers turn on to Highway 81 from Emory Way, they are going to be focused on increasing speed to the flow of traffic and will have to stop suddenly for the crossing. Mayor Eady stated that they will see the flashing light as soon as they turn.

Laura McCanless stated that the bottom line is a crosswalk is needed for the park patrons in this area, and if the proposed design is what GDOT will approve, the City should not waste time discussing alternate designs that GDOT will not approve.

Art Vinson questioned the rationale of placing the crosswalk nearer to the cemetery rather than nearer to the pavilion and playground, since people using it would be more likely headed toward the pavilion and playground. He suggested moving the crosswalk further south. This change would also provide more room to make visual contact with the rapid-flash beacons and pedestrians after turning from Collingsworth Street and Emory Way onto Highway 81.

Mayor Eady advised that moving the crosswalk further south would increase the complexity of the project because the ground is soft and wet between Collingsworth Street and the park. Mr. Vinson stated this disadvantage could be turned into a feature by using catwalks to navigate the swampy area.

Jeff Wearing asked if Mr. Renwick could provide some alternatives that he believes GDOT will approve. He agrees with Mr. Vinson that safety of children crossing is the most important thing, even if it increases the cost of the project.

Mr. Renwick stated there may be options to move the crosswalk further south. He will study these options and provide additional recommendations. He advised that temporary easements will be needed in a couple of places at driveways and on slopes. Formal



easements are not necessary; these can be rights of entry agreements with the property owners.

Mayor Eady asked Mr. Renwick to update the project schedule. He knows there has been some project slippage and would like more accurate information on when the request for bids should go out and when construction should begin. Mr. Renwick will update the schedule and add some risks and a critical path.

4. **MEAG Power Resolution for Municipal Competitive Trust Fund** (Attachment C)  
Oxford identifies two independent City officials by resolution to communicate decisions of the City regarding its Municipal Competitive Trust Fund. In 2020, Mayor David Eady and City Manager Matthew Pepper were identified as the two City officials. Since Matthew Pepper is no longer employed with the City of Oxford, the resolution must be updated. In consultation with MEAG, the City proposes replacing specific names on this document with titles so that it does not require updating each time the person in the position changes.

No concerns were raised by the Councilmembers.

5. **MEAG 2022 Capacity Needs** (Attachment D)  
The City of Oxford has been advised by MEAG that it has a capacity shortage for 2022 of 907 kw (484 kw Reserve and 485 kw Supplemental). The City of Elberton has agreed to sell capacity at a negotiated rate of \$6/kw-yr. for Reserve Capacity and \$8/kw-yr. for Supplemental Capacity. Market rates are \$9.54 and \$15.38 respectively. The total cost would be \$6,784 [(484 kw x \$6) + (485 kw x \$8)].

Mayor Eady stated MEAG shops around for the best rates for cities that have a capacity shortage and brokers those deals. The rates offered by the City of Elberton are favorable compared to the market rates. He also stated that that once the solar portion of our portfolio comes online, the City should not have an annual shortage.

No concerns were raised by the Councilmembers.

6. **Oxford Police Department Body Camera Storage Process** (Attachment E)  
The Oxford Police Department currently stores body camera footage on external hard drives. The current upload process for the footage is time consuming and cumbersome, and speed of upload is contingent upon an officer being available to perform the process. The Police Department has received a proposal from the vendor of their cameras for a 60-month agreement to provide cloud storage for body camera footage.

The storage process is proprietary to the brand of cameras and using a different storage service would require purchase of new cameras. Therefore, competitive bids cannot be obtained for this service without replacement of the cameras, which is not necessary at this time. Installation costs are \$1,563.00 and there is a recurring annual cost of \$1,392.00 for 60 months. Chief Harvey recommends approval of the contract. The installation costs include setup of the chargers for the cameras and training in use of the software.

Laura McCanless asked how old the Police Department's cameras are and if they will last through the five-year contract. She also asked how the company is rated. Chief Harvey stated that the company is Axon Enterprises, and they provide most of the cameras in use today. The company also supplies Oxford's tasers. They have had one or two cameras break down, but Axon has been good about working with Oxford within the warranty.

Ms. McCanless asked if the application will support new cameras if any new ones must be bought. Chief Harvey stated it is a simple process to add new cameras to the application.

Ms. McCanless asked if the company has provisions for a backup of the camera footage. Mayor Eady stated that most cloud storage services have redundancies in place. City Attorney David Strickland has also reviewed the contract and had no concerns about it.

George Holt stated that he saw some language about tasers but saw nothing about body cameras in the terms of the contract. After further review, it was determined that this language is referring to the licensing products, and the license Oxford is getting is for Axon Evidence. The terms are all-encompassing to cover all of Axon's products.

**7. Purchase of 47' Derrick Truck for Public Works Department (Attachment F)**

The FY 2021 Capital Budget includes funds for replacement of the Public Works' derrick truck. Bids were received from two vendors. Availability of vendors for this product is very limited. Staff recommends awarding the contract for this equipment to Altec, the low bidder, for \$207,290. Delivery of the truck will take approximately one year, so the order needs to be placed since there are already mechanical problems with the current equipment.

Jody Reid explained that this equipment is the City's line truck that is used to set poles and remove trees that have fallen on lines. It is also used to set transformers. It is about thirty years old, was purchased in used condition, and has had some major work. The turntable and main boom need rebuilding, which are very costly repairs. It is dangerous to use without repairs.

George Holt asked when the City started setting its own poles, as he was under the impression the City contracts this work out. Mr. Reid stated that the City sets poles anytime they are broken by storm damage, and they set poles for new service.

Mayor Eady stated that the City Council can vote on the purchase in October as a formality but can go ahead and order it since the current equipment is dangerous. The cost has increased since the bid was obtained for the Capital budget. Marcia Brooks stated that the City will not pay for the equipment until next fiscal year, so a budget amendment may not be needed for the current fiscal year.

**8. Replacement of Gutter Guards at City Hall (Attachment G)**

It was recently discovered that the gutter guards installed on the City Hall building when it was built are rotten and need to be replaced. Staff has obtained three bids for performance of this work and recommends that the City contract with the low bidder, KJGR, LLC, for \$5,400.00 to complete this work using Leaf Blaster products.

Laura McCanless stated that the product is aluminum with stainless steel perforated mesh and ribbing to allow leaves to run off.

**9. Other Business**

No other business was raised.

**10. Work Session Meeting Review**

- a. Emory Street Sidewalk Improvements – Robert Renwick with Keck & Wood to provide additional options for crosswalk alignment, lighting options, and project schedule update
- b. MEAG Power Resolution for MCT Fund – vote in October regular session
- c. MEAG 2022 Capacity Needs – vote in October regular session
- d. Oxford Police Department Body Camera Storage Process – vote in October regular session
- e. Purchase of 47' Derrick Truck for Public Works Department – vote in October regular session
- f. Replacement of Gutter Guards at City Hall – vote in October regular session

**11. Executive Session**

The City Council entered Executive Session at 7:55 p.m. to discuss real estate matters.

The City Council adjourned from Executive Session at 8:01 p.m.

**12. Adjourn**

**Mayor Eady adjourned the meeting at 8:02 p.m.**

Respectfully Submitted,

Marcia Brooks  
City Clerk/Treasurer

# OXFORD PLANNING COMMISSION

Minutes – July 13, 2021

**MEMBERS:** Jonathan Eady, Chair; Zach May, Vice Chair; Juanita Carson, Secretary; Mike Ready, and Jeremy Baker. Mike McQuaide was absent.

**STAFF:** None.

**GUESTS:** Terry Clayton; Carolyn King; Hugh Burnett and Josephine Kelly; Randy Simon, Director of Facilities Planning and Operations, Oxford College; Scott Daniell; unknown developer.

**OPENING:** At 7:00 PM, Mr. Eady called the meeting to order and welcomed the guests.

**MINUTES:** Upon motion of Mr. May, seconded by Mr. Ready, the minutes for the meeting of June 8, 2021 were adopted. The vote was 5-0.

**TERRY CLAYTON DEVELOPMENT PERMIT APPLICATION (1406 Emory Street):** The Commission reviewed the development permit application to replace the existing windows and siding on the front side of the house located at 1406 Emory Street. During the discussion, the Commission confirmed that Mr. Clayton would replace the existing siding with hardiplank.

*Upon motion of Mr. Ready, seconded by Mr. May, the Planning Commission approved the development permit application to replace the existing windows and siding on the front side of the house located at 1406 Emory Street. The vote was 5-0.*

**OXFORD COLLEGE DEVELOPMENT PERMIT APPLICATION (1205 Wesley Street):** The Commission reviewed the development permit application to replace the furnace in the house located at 1205 Wesley Street.

*Upon motion of Ms. Carson, seconded by Mr. Ready, the Planning Commission approved the development permit application to replace the furnace in the house located at 1205 Wesley Street. The vote was 4-0 with Mr. Eady abstaining.*

**RENOVATION DISCUSSION WITH JOSEPHINE KELLY AND HUGH BURNETT (205 Fletcher Street):** Ms. Kelly and Mr. Burnett requested an opportunity to discuss with the Planning Commission their plans to improve the existing house located at 205 Fletcher Street. During the discussion, Ms. Kelly and Mr. Burnett explained that they are considering converting the existing house from a duplex to a single-family home. As part of the renovation, they would enclose the garage and add gables to either side.

The Commission noted that the existing house does not meet the side setback requirements. Consequently, Ms. Kelly and Mr. Burnett must apply for a variance to make the desired improvements. The Commission took no action.

**CAROLYN KING DEVELOPMENT PERMIT APPLICATION (128 Longstreet Circle):** The Commission reviewed the development permit application to install a 6 x 6 storage shed in the rear yard of the property located at 128 Longstreet Circle. During the discussion, the Commission confirmed that the proposed location for the storage shed met the side and rear setbacks. In addition, the Commission amended the permit application's scope of work to include replacing the windows and installing a fence.

*Upon motion of Mr. Ready, seconded by Mr. Baker, the Planning Commission approved the development permit application to replace the existing windows, and install a fence and a 6 x6 storage shed in the rear yard of the property located at 128 Longstreet Circle. The vote was 5-0.*

**OTHER BUSINESS:** Scott Daniell and a developer inquired about the Commission's thoughts on a proposed retirement community in Oxford. They did not have a specific location for the project. They



also inquired about the city's zoning information and lot sizes. The Commission took no action on the inquiry.

**ADJOURNMENT:** Mr. Eady adjourned the meeting at 8:09 PM.

Submitted by:

Juanita Carson, Secretary

# OXFORD TREES, PARKS AND RECREATION BOARD

Minutes – August 17, 2021

**MEMBERS:** Cheryl Ready, Chair; Michael Rogers, Vice Chair; Anderson Wright, Mike McQuaide. Theresa Eady, Secretary; Amos Downs, and Nakeisha Cummings were absent.

**STAFF:** Beryl Budd, City Arborist; Jody Reid, Utilities Superintendent.

**GUESTS:** Kate Carson, Nicholas

**OPENING:** At 5:00 PM, Ms. Ready called the meeting to order and welcomed the guests.

**MINUTES:** Upon motion of Mr. Ready, seconded by Mr. Wright, the minutes for the meeting of July 20, 2021 were adopted. The vote was 4-0.

**EMORY STREET TREE REPLACEMENT PROJECT (moved up due to delayed arrival of Reforest ATL representatives):** The Board discussed their project to replace the tree canopy on Emory Street/SR 81. Amos Downs provided a project assignment sheet to facilitate dividing the locations chosen for the project into sectors. The members chose areas to canvass and assigned an area to Theresa Eady, per her previous request.

**ASBURY STREET PARK AND CITY TRAIL MAINTENANCE:** Representatives from Reforest ATL, a company that provides ecological restoration services, spoke to the group. They discussed their approach to look at an area as an ecosystem and come up with a plan to get the ecosystem stabilized. They advocate a phased approach to removing invasive species coinciding with native plantings. This approach is budget-friendly and also helps reduce shock to the system that could end up inviting more invasive species to the area.

They would need an idea of scope and would develop a plan to present to the board. They advised that they could work in an area without much disturbance since they use mostly hand tools. They can provide professional labor or can work with volunteer groups, training them to recognize native vs. invasive plants.

Attendees named several possible areas of the City as candidates for this type of intervention, including parks, rights-of-way on edges of yards, trails, cemeteries, and wetlands/creek banks. The company would help the group determine priorities for which areas to work on first. The board agreed to use Asbury Street Park as the pilot since it has a defined area including a marshy, aquatic component, and there are some native plantings already there. Ms. McCanless will be the liaison with the City Council for the project. She will also work on getting a second bid for the services.

**CITY TREE INVENTORY:** Mr. Budd reported that with the assistance of Yaling Covey, the intern from Oxford College, they had surveyed 902 trees, which covers about half of the trees on the City rights-of-way. Many of them need mulching and/or pruning. He reported that the overall health of the tree canopy is excellent; only about a half dozen of the trees need removing. Mr. Reid stated this was largely due to the annual capping and removal of dead limbs/trimming that the City engages in. Mr. Budd indicated he would like to get the information in the survey on the County GIS. He praised the work of the Oxford College intern, Ms. Covey. Ms. Ready stated she would like to send Ms. Covey a gift and thank-you card. The attendees agreed.

## **OTHER BUSINESS:**

- The attendees completed the annual Arbor Day tree survey together.

- Ms. Ready asked for verification that dues are being paid to the Arbor Day Foundation and the Georgia Tree Council. Marcia Brooks will verify. She asked for consensus to spend \$30 to become a member of the Arbor Day Foundation, which was obtained.
- Ms. Ready announced that Arbor Day will be celebrated on February 19, 2022. She asked for input on what type of program the City should have. Should schools be involved? Should it be held outside? She believes it should be low key. She asked the attendees to think about ideas before the September meeting.
- Mr. Ready stated that one of the Sustainability Committee's goals is to be in coordination with other committees and to create dialogue with them. It was suggested that Melissa Hage, Chair of the Sustainability Committee might come in the Fall and speak to the Board.

**ADJOURNMENT:** Ms. Ready adjourned the meeting at 6:23 PM.

Submitted by:

Theresa Eady, Secretary



# **DOWNTOWN DEVELOPMENT AUTHORITY OF THE CITY OF OXFORD**

Minutes – August 24, 2021

**MEMBERS:** Mr. Brian Barnard, Chair; Mr. Mike Ready, Vice-Chair; Mr. Jonathan Eady, Ms. Laura McCanless, Mr. Ray Wilson and Ms. Danielle Miller.

**STAFF:** Marcia Brooks, City Clerk/Treasurer.

**GUESTS:** No guests were in attendance.

**OPENING:** At 7:01 p.m. Mr. Barnard called the meeting to order.

**APPROVAL OF MINUTES:** Upon motion of Mr. Eady, seconded by Mr. Ready, the minutes for the meeting held on July 27, 2021 were approved. The vote was 6 – 0.

**THE CITY GREENSPACE:** The Authority discussed the improvements planned for the City Greenspace. Ray Wilson advised that he had received some quotes for the fencing and landscaping and would forward them to the group after the meeting. He advised the group of some of the details of the landscaping quotes. Ms. McCanless mentioned that the City Council had passed a resolution in the past year requiring native plantings on all City properties. The plants Ray mentioned from the quotes are non-native. The quotes will need to be revised in consultation with the listing included with the City Council's resolution. Ms. McCanless asked Marcia Brooks to send the list to all attendees.

**EXECUTIVE SESSION:** At 7:38 p.m., Mr. Eady made a motion to go into executive session, seconded by Ms. McCanless. Real estate matters were discussed during executive session. At 8:28 p.m., Mr. Eady made a motion to exit executive session, seconded by Mr. Ready.

**OTHER BUSINESS:** None.

**ADJOURNMENT:** Mr. Eady adjourned the meeting at 8:29 p.m.

Submitted by:

Marcia Brooks, City Clerk/Treasurer

**Resolution of  
OXFORD/NEWTON COUNTY**

WHEREAS, the City is a Beneficiary of the Municipal Competitive Trust (the "Trust") that MEAG Power established as of January 1, 1999; and

WHEREAS, pursuant to the terms of the Trust, the City is allowed to transfer certain funds between accounts and withdraw certain funds from accounts by written direction to MEAG Power and the Trustee; and

WHEREAS, by official action of the City, a City official was delegated authority to make deposits to the Trust and to communicate City decisions with respect to the Trust to MEAG Power and the Trustee; and

WHEREAS, in order to improve the notification process, MEAG Power has requested that all written directions communicating City decisions with respect to the Trust be executed by two independent City officials; and

WHEREAS, the City, after due consideration, has determined that such procedural changes are in the best interest of the City.

NOW, THEREFORE, BE IT RESOLVED that henceforth the Mayor of the City of Oxford and the City Manager of the City of Oxford (together, the "Authorized Officials") are authorized to communicate City decisions with respect to the Trust by jointly executing written directions to MEAG Power and the Trustee; and

FURTHER RESOLVED that the City hereby authorizes the Authorized Officials to execute, and the City Clerk to attest and deliver, certificates specifying the names, titles, term of office and specimen signatures of the Authorized Officials and other certificates and documents that MEAG Power may require from time to time to effect the purposes of the Trust and this Resolution.

This the \_\_\_\_ day of \_\_\_\_\_, 2021.

ATTEST:

\_\_\_\_\_  
City Clerk  
[SEAL]

\_\_\_\_\_  
\_\_\_\_\_

## Marcia Brooks

---

**To:** Marcia Brooks  
**Subject:** RE: 2022 Capacity needs

---

**From:** Bisig, Holly <[hbisig@meagpower.org](mailto:hbisig@meagpower.org)>  
**Sent:** Wednesday, September 15, 2021 8:54 AM  
**To:** Bill Andrew <[bandrew@oxfordgeorgia.org](mailto:bandrew@oxfordgeorgia.org)>  
**Subject:** 2022 Capacity needs

Morning Bill – it's time to review the annual capacity needs for 2022. Oxford is short next year by a total of 970kw (484kw in Reserve and 485kw in Supplemental).

The City of Elberton has agreed to sell capacity at a negotiated rate of \$6/kw-yr for Reserve Capacity and \$8/kw-yr for Supplemental Capacity. Market rates are \$9.54 and \$15.38 respectively.

Oxford would be paying to Elberton:

484kw \* \$6 = \$2,904

485kw \* \$8 = \$3,880

If you are in agreement with these prices I can go ahead and get the paperwork started. We have new deadlines in place this year and we have to get these fully executed by the end of 2021; so to get through council meetings we need to get these agreements out to the cities by early October.

Holly B.



Holly Bisig  
Sr Regional Manager  
Office: 770-661-2889  
Mobile: 404-936-4381  
Email: [hbisig@meagpower.org](mailto:hbisig@meagpower.org)

The information contained in this email is privileged and confidential information intended for the use of the addressee listed above. If you are neither the intended recipient nor the employee or agent responsible for delivering this message to its intended recipient, you are hereby notified that any disclosure, copying, distribution or the taking of any action in relation to the contents of the email information is strictly prohibited. If you have received this email in error, please notify the sender immediately by telephone or reply email and destroy this email and any attachments.

AUTHORIZATION AGREEMENT  
Year 2022 Annual Subscription  
Under Supplemental Power Supply Policy  
between  
Municipal Electric Authority of Georgia  
and

\_\_\_\_\_  
(Participant)

In accordance with the MEAG Supplemental Power Supply Policy, the Undersigned Participant hereby elects to: (all Participants must elect one option and return)

- (i) \_\_\_\_\_ (Opt-out) Acquire the necessary resources for its Supplemental Power Supply Requirements itself;
- (ii) \_\_\_\_\_ (Annual Self Supply) acquires the necessary resources for its Supplemental Power Supply Requirements for the Power Supply year itself through an Inter-Participant Transfer (IPT) Agreement [or off system purchase power contract];
- (iii) \_\_\_\_\_ (Subscription) Subscribe to one or more of the power supply alternatives identified in the attached Nomination Form in specific amounts;
- (iv) \_\_\_\_\_ (Agent) Designate MEAG as its agent to nominate and acquire any combination of resources to optimize their Supplemental Power Supply Requirements. Please specify agency limitations if any, \_\_\_\_\_;

**or**

- (v) \_\_\_\_\_ Nominate my excess capacity for supplemental at \$15.38/kW-Yr plus the hourly energy market price or for reserves at \$9.54/kW-Yr at DP. Supplemental will be allocated first, then any remaining amounts will be allocated to reserves. Please specify amount and limitations if any, \_\_\_\_\_.

By executing this Authorization Agreement, Participant understands that MEAG will aggregate all MEAG Participant nominations and attempt to contract for the total amount of Participant supplemental power supply requirements nominated under this Annual Subscription. Participant also understands that MEAG will purchase the capacity necessary to ensure that system planning reserve requirements are met and assign this capacity for one or more years to those Participants deemed capacity deficient. Participant agrees that these reserve capacity purchases may be made at “market” prices from other Participants.

Participant agrees to and accepts the above nomination, this \_\_\_\_\_ day of \_\_\_\_\_, 2021.

Participant: \_\_\_\_\_

By: \_\_\_\_\_

\_\_\_\_\_,  
Mayor or other authorized representative

*Chief W. D. Harvey  
110 W. Clark St.  
Oxford, GA 30054*



## **Memorandum**

August 23, 2021

**To:** Mayor David Eady

**From:** Chief WD Harvey

**Subject:** Body Cameras Storage Process

Regarding body cameras for the police department, it has become necessary to update our system with a more efficient process of video storage.

We purchased our first body cameras in February 2015 from Axon. The current process of our department depends on myself being available to download each camera each day when I come into work, taking over two hours most of the time. The videos are downloaded to an external hard drive, renamed, and filed. They are then copied and filed on a second hard drive as a backup due to computers issues in the past in which we lost some of the files. When the hard drives reach their capacity, one is placed in property and evidence and the files on the main hard drive are deleted. A new hard drive is purchased for a new back up and the process is repeated. In order to maintain as much space as possible, files are dated and labelled to delete according to the state retention guidelines. Time has not allowed me to maintain this process as I had planned. If I am off for vacation or an unexpected reason, the videos are downloaded by an officer to a temporary file until my return, then there is the issue of trying to catch up and deal with the current videos that continue each day.

Most departments now are taking advantage of programs such as Evidence.Com, which allows the officers to label each video and the videos are then placed in a charger at the end of the shift and transferred to the storage location within ninety seconds in most cases. A retention plan is programmed into the system and videos are saved or deleted according to the guidelines entered. With this process, the department process is not dependent on one certain person and can continue to operate on its own. Files are also available immediately if needed by an investigator or the DA's office.

Using the cameras we currently have, we can convert them over from offline service to online service, which will meet our need. The fee for the process is \$1392.00 per year with a 5-year contract with Axon, totaling \$8523.00. No changes would have to be made to the current approved budget and the cost would come from my maintenance budget. With the change requiring a 5-year contract, I would need your approval, as well as the council's approval, to proceed.

I am available to answer any questions at any time.





**Axon Enterprise, Inc.**  
 17800 N 85th St.  
 Scottsdale, Arizona 85255  
 United States  
 VAT: 86-0741227  
 Domestic: (800) 978-2737  
 International: +1.800.978.2737

**Q-331786-44424.831RM**

Issued: 08/16/2021  
 Quote Expiration: 09/30/2021  
 EST Contract Start Date: 11/01/2021  
 Account Number: 412245  
 Payment Terms: N30  
 Delivery Method: Fedex - Ground

SHIP TO	BILL TO
Business;Delivery;Invoice-110 W Clark St 110 W Clark St Oxford, GA 30054-2274 USA	Oxford Police Dept. - GA  110 W Clark St Oxford, GA 30054-2274 USA Email:

SALES REPRESENTATIVE	PRIMARY CONTACT
Rob Marangelo  Phone: Email: rmarangelo@axon.com Fax:	David Harvey  Phone: (770) 788-1390 Email: dharvey@oxfordgeorgia.org Fax: (770) 786-2211

Program Length	60 Months
<b>TOTAL COST</b>	\$8,523.00
<b>ESTIMATED TOTAL W/ TAX</b>	\$8,523.00

Bundle Savings	\$144.00
Additional Savings	\$0.00
<b>TOTAL SAVINGS</b>	\$144.00

PAYMENT PLAN		
PLAN NAME	INVOICE DATE	AMOUNT DUE
Year 2		\$1,392.00
Year 5		\$1,392.00
Year 4		\$1,392.00
Year 3		\$1,392.00
Year 1		\$1,392.00

## Quote Details

Bundle Summary		
Item	Description	QTY
Flex2MBD	Flex 2 Multi-Bay Dock Bundle	1
ProLicense	Pro License Bundle	1
BasicLicense	Basic License Bundle	3

Individual Items USD			
Category	Item	Description	QTY
Other	73683	10 GB EVIDENCE.COM A-LA-CART STORAGE	80

Bundle: Flex 2 Multi-Bay Dock Bundle    Quantity: 1    Start: 11/1/2021    End: 10/31/2026    Total: 1563 USD				
Category	Item	Description	QTY	
Dock	11537	DOCK, FLEX 2, 6-BAY + CORE	1	
Power Cord	71019	NORTH AMER POWER CORD FOR AB3 8-BAY, AB2 1-BAY / 6-BAY DOCK	1	

Bundle: Pro License Bundle    Quantity: 1    Start: 11/1/2021    End: 10/31/2026    Total: 2340 USD				
Category	Item	Description	QTY	
E.com License	73746	PROFESSIONAL EVIDENCE.COM LICENSE (Formerly SKU 73746)	1	
A La Carte Storage	73683	10 GB EVIDENCE.COM A-LA-CART STORAGE	3	

Bundle: Basic License Bundle    Quantity: 3    Start: 11/1/2021    End: 10/31/2026    Total: 2700 USD				
Category	Item	Description	QTY	
E.com License	73840	EVIDENCE.COM BASIC LICENSE	3	
A La Carte Storage	73683	10 GB EVIDENCE.COM A-LA-CART STORAGE	3	

Tax is estimated based on rates applicable at date of quote and subject to change at time of invoicing. If a tax exemption certificate should be applied, please submit prior to invoicing.



## Standard Terms and Conditions

### Axon Enterprise Inc. Sales Terms and Conditions

#### Axon Master Services and Purchasing Agreement:

This Quote is limited to and conditional upon your acceptance of the provisions set forth herein and Axon's Master Services and Purchasing Agreement (posted at [www.axon.com/legal/sales-terms-and-conditions](http://www.axon.com/legal/sales-terms-and-conditions)), as well as the attached Statement of Work (SOW) for Axon Fleet and/or Axon Interview Room purchase, if applicable. In the event you and Axon have entered into a prior agreement to govern all future purchases, that agreement shall govern to the extent it includes the products and services being purchased and does not conflict with the Axon Customer Experience Improvement Program Appendix as described below.

#### ACEIP:

The Axon Customer Experience Improvement Program Appendix, which includes the sharing of de-identified segments of Agency Content with Axon to develop new products and improve your product experience (posted at [www.axon.com/legal/sales-terms-and-conditions](http://www.axon.com/legal/sales-terms-and-conditions)), is incorporated herein by reference. By signing below, you agree to the terms of the Axon Customer Experience Improvement Program.

#### Acceptance of Terms:

Any purchase order issued in response to this Quote is subject solely to the above referenced terms and conditions. By signing below, you represent that you are lawfully able to enter into contracts. If you are signing on behalf of an entity (including but not limited to the company, municipality, or government agency for whom you work), you represent to Axon that you have legal authority to bind that entity. If you do not have this authority, please do not sign this Quote.

---

Signature

---

Date Signed

8/16/2021





By using an Axon Enterprise, Inc. (“**Axon**”) desktop software (“**Software**”), you indicate your agreement to the terms of this License Agreement (“**Agreement**”). Axon owns the Software, all executable instructions, images, icons, sound, and text incorporated in the Software. United States copyright laws and international treaty provisions protect Axon’s ownership of the Software. Except to the extent expressly licensed in this Agreement, all rights are reserved to Axon.

**USE OF THE SOFTWARE IS SUBJECT TO THE TERMS SET FORTH BELOW. USING THE SOFTWARE INDICATES YOUR ACCEPTANCE OF THESE TERMS. IF YOU DO NOT ACCEPT THESE TERMS, YOU MAY NOT COPY OR USE THE SOFTWARE.**

1. **License Grant.** Axon grants to you a non-exclusive, royalty-free, worldwide right and license to use the Software, where “use” and “using” in this Agreement mean storing, loading, installing, or executing the Software exclusively for data communication with an Axon product. You may use the Software in a networked environment on computers other than the computer on which the Software is installed if each execution of the Software is for data communication with an Axon product. You may make copies and adaptations of the Software for archival purposes and when copying or adaptation is an essential step in the authorized use of the Software if you retain all copyright, trademark, and proprietary notices in the original Software on all copies or adaptations. You may copy the written materials accompanying the Software.

2. **Prohibited Acts.** You may not modify the Software or disable any licensing or control features of the Software. You may not rent or lease your rights to the Software or documentation. You may not reverse engineer the Software to obtain source code. The license does not include a grant of any right to use source code obtained or devised as a result of reverse engineering. The license grant does not include a grant of any right under any patent or trademark of Axon.

3. **Ownership.** Except provided in this Agreement, all rights to the Software belong to Axon. Your license confers neither title to nor ownership in the Software and is not a sale of any rights in Axon. Axon owns and reserves all right, title, and interest in the Software, including any suggestions to Axon. Axon has and claims proprietary rights in the Software, and integration of ancillary materials, knowledge, and designs constituting Axon products and services. You will not directly or indirectly cause any Axon proprietary rights to be violated.

4. **License Restrictions.** You may not use the Software in any manner or for any purpose other than as expressly permitted by this Agreement. You may not: (a) modify, alter, tamper with, repair, or otherwise create derivative works of the Software; (b) reverse engineer, disassemble, or decompile the Software or apply any other process or procedure to derive the source code of the Software, or allow any others to do the same; (c) access or use the Software in a way intended to avoid incurring fees or exceeding usage limits or quotas; (d) copy the Software in whole or part, except as expressly permitted in this Agreement; (e) use trade secret information contained in the Software, except as expressly permitted in this Agreement; (f) resell, rent, loan or sublicense the Software; (g) access the Software in order to build a competitive product or service or copy any features, functions or graphics of the Software; or (h) remove, alter or obscure any confidentiality or proprietary rights notices (including copyright and trademark notices) of Axon or our licensors on or within the Software or any copies of the Software. All licenses granted to you in this Agreement are conditional on your continued compliance with this Agreement, and will immediately and automatically terminate if you do not comply with any term or condition of this Agreement. During the term of your use of the Software and after, you will not assert, nor will you authorize, assist, or encourage any third party to assert, against us or any of our affiliates, customers, vendors, business partners, or licensors, any patent infringement or other intellectual

---

property infringement claim regarding the Software.

5. **Support.** Axon may make available to you updates and error corrections (collectively, "**Updates**") to the Software. Axon may provide Updates electronically via the Internet or via media as determined solely by Axon. It is your responsibility to establish and maintain adequate access to the Internet in order to receive the updates. Axon does not provide Internet Service Provider (ISP) services. You are responsible for maintaining the computer equipment necessary for your use of the Software. At its sole discretion, Axon may provide technical support for the current and prior release(s)/version(s) of the Software for a period of six (6) months following the date the Axon makes the subsequent release/version generally available.

6. **Disclaimers.** AXON PROVIDES THE SOFTWARE "AS IS." AXON AND OUR AFFILIATES AND LICENSORS MAKE NO REPRESENTATIONS OR WARRANTIES OF ANY KIND, WHETHER EXPRESS, IMPLIED, STATUTORY OR OTHERWISE REGARDING THE SOFTWARE, INCLUDING ANY WARRANTY THAT THE SOFTWARE WILL BE UNINTERRUPTED, ERROR FREE OR FREE OF HARMFUL COMPONENTS, OR THAT ANY CONTENT, INCLUDING YOUR CONTENT OR THE THIRD PARTY CONTENT, WILL BE SECURE OR NOT OTHERWISE LOST OR DAMAGED. EXCEPT TO THE EXTENT PROHIBITED BY LAW, AXON AND OUR AFFILIATES AND LICENSORS DISCLAIM ALL WARRANTIES, INCLUDING ANY IMPLIED WARRANTIES OF MERCHANTABILITY, SATISFACTORY QUALITY, FITNESS FOR A PARTICULAR PURPOSE, NON-INFRINGEMENT, OR QUIET ENJOYMENT, AND ANY WARRANTIES ARISING OUT OF ANY COURSE OF DEALING OR USAGE OF TRADE.

7. **Limitation of Liability.** AXON AND OUR AFFILIATES OR LICENSORS WILL NOT BE LIABLE TO YOU FOR ANY DIRECT, INDIRECT, INCIDENTAL, SPECIAL, CONSEQUENTIAL OR EXEMPLARY DAMAGES (INCLUDING DAMAGES FOR LOSS OF PROFITS, GOODWILL, USE, OR DATA), EVEN IF A PARTY HAS BEEN ADVISED OF THE POSSIBILITY OF SUCH DAMAGES. FURTHER, NEITHER AXON NOR ANY OF OUR AFFILIATES OR LICENSORS WILL BE RESPONSIBLE FOR ANY COMPENSATION, REIMBURSEMENT, OR DAMAGES ARISING IN CONNECTION WITH: (A) YOUR INABILITY TO USE THE SOFTWARE, INCLUDING AS A RESULT OF ANY (i) TERMINATION OR SUSPENSION OF THIS AGREEMENT OR YOUR USE OF OR ACCESS TO THE SOFTWARE, (ii) DISCONTINUATION OF A PORTION OR ALL OF THE SOFTWARE, OR, (iii) WITHOUT LIMITING ANY OTHER OBLIGATIONS, ANY UNANTICIPATED OR UNSCHEDULED DOWNTIME OF ALL OR A PORTION OF THE SOFTWARE FOR ANY REASON, INCLUDING AS A RESULT OF POWER OUTAGES, SYSTEM FAILURES OR OTHER INTERRUPTIONS; (B) THE COST OF PROCUREMENT OF SUBSTITUTE SOFTWARE, GOODS OR SERVICES; (C) ANY INVESTMENTS, EXPENDITURES, OR COMMITMENTS BY YOU IN CONNECTION WITH THIS AGREEMENT OR YOUR USE OF OR ACCESS TO THE SOFTWARE; OR (D) ANY UNAUTHORIZED ACCESS TO, ALTERATION OF, OR THE DELETION, DESTRUCTION, DAMAGE, LOSS OR FAILURE TO STORE ANY OF YOUR CONTENT OR OTHER DATA. IN ANY CASE, AXON AND OUR AFFILIATES' AND LICENSORS' AGGREGATE LIABILITY UNDER THIS AGREEMENT WILL BE LIMITED TO THE AMOUNT YOU ACTUALLY PAY AXON UNDER THIS AGREEMENT FOR THE SOFTWARE THAT GAVE RISE TO THE CLAIM DURING THE 12 MONTHS PRECEDING THE CLAIM.

8. **Remedies.** YOUR EXCLUSIVE REMEDY IS, AT AXON'S SOLE OPTION, REPAIR OR REPLACEMENT OF THE SOFTWARE OR REFUND OF PART OR THE ENTIRE LICENSE FEE, IF ANY, PAID BY YOU FOR THE SOFTWARE.

9. **Offline Mode.** Axon is not liable for any improper or incorrect use of the data collected by, distributed by, or downloaded with the Software in Offline Mode. Once you transfer data from the TASER or Axon brand product to your local computer, Axon makes no guarantee or warranty that the data cannot be altered or will remain in its original format. It is your responsibility to monitor data storage, usage and collection. Axon gives no warranty, expressed or implied, as to the accuracy, reliability, or completeness of the data collected by, distributed by, or downloaded with the Software in Offline Mode. Although this data may have been captured successfully by a TASER or Axon brand product, no warranty expressed or implied is made regarding the utility of the data on another system or for general or evidentiary purposes, nor will the act of distribution constitute any such warranty. This disclaimer applies to individual use of the data and aggregate use with other data.

10. **Termination.** This Agreement will continue for the duration of Axon's copyright in the Software, unless earlier terminated as provided in this Agreement. Axon may terminate your license immediately without notice to you for your failure to comply with any of the terms set forth in this Agreement. Upon termination, you must immediately destroy the Software, together with all copies, adaptations and merged portions thereof in any form. Obligations to pay accrued charges or fees will survive the termination of this Agreement.

11. **Assignment.** Neither party may assign or otherwise transfer this Agreement or any of its rights and obligations under this Agreement without the prior written approval of the other party. Notwithstanding the above, either party may assign or otherwise transfer this Agreement or any of its rights or obligations under this Agreement without the consent of the other party (a) in connection with a merger, acquisition or sale of all or substantially all of its assets, or (b) to as part of a corporate reorganization. Subject to the foregoing, this Agreement will be binding upon, and inure to the benefit of the parties and their respective successors and assigns.

12. **No Third Party Beneficiaries.** This Agreement does not create any third party beneficiary rights in any individual or entity that is not a party to this Agreement.

13. **Export Requirements.** You may not export or re-export the Software or any copy or adaptation in violation of any applicable laws or regulations.

14. **U.S. Government Rights.** If you are a U.S. Federal department or using Axon the Software behalf of U.S. Federal department, Software provided as a "commercial item," "commercial computer software," "commercial computer software documentation," and "technical data", as defined in the Federal Acquisition Regulation and Defense Federal Acquisition Regulation Supplement. If you are using Software on behalf of the U.S. Government and these terms fail to meet the U.S. Government's needs or are inconsistent in any respect with federal law, you will immediately discontinue use of the Software.

15. **Entire Agreement.** Unless otherwise expressly agreed in writing, this Agreement constitutes the sole and exclusive agreement between you and Axon with regard to the Software, and supersedes all prior agreements, whether oral or written, and other communications between the parties relating to the subject matter set forth in this Agreement. You agree that your purchase or use of the Software is neither contingent on the delivery of any future functionality or features nor dependent on any oral or written public comments made by Axon regarding future functionality or features of the Software. No modification or amendment of any portion of this Agreement will be effective unless in writing and signed by the parties to this Agreement. If Axon provides a translation of the English language version of this Agreement, the English language version of the Agreement will control if there is any conflict.



**16. No Waivers.** The failure by either party to enforce any provision of this Agreement will not constitute a present or future waiver of the provision nor limit the party's right to enforce the provision later. All waivers by a party must be in writing.

**17. Severability.** If a court of competent jurisdiction holds any portion of this Agreement invalid or unenforceable, the remaining portions of this Agreement will remain in effect.

**18. Governing Law; Venue.** The laws of the State of Arizona, without reference to conflict of law rules, govern this Agreement and any dispute of any sort that might arise between the parties. Any dispute relating in any way to the Software or this Agreement must only be adjudicated in a state or federal court located in Maricopa County, Arizona. Each party consents to exclusive jurisdiction and venue in these courts. Notwithstanding the foregoing, either party may seek injunctive relief in any state, federal, or national court of competent jurisdiction for any actual or alleged infringement of that party's or any third party's intellectual property or other proprietary rights. The United Nations Convention for the International Sale of Goods does not apply to this Agreement.

▲ AXON, Axon, and TASER are trademarks of Axon Enterprise, Inc. some of which are registered in the US and other countries. For more information, visit [www.axon.com/legal](http://www.axon.com/legal). All rights reserved. © 2018 Axon Enterprise, Inc.



## Master Services and Purchasing Agreement between Axon and Agency (Online)

This Master Services and Purchasing Agreement (“**Agreement**”) is between Axon Enterprise, Inc., a Delaware corporation (“**Axon**”), and the agency on the Quote (“**Agency**”). This Agreement is effective as of the later of the (a) last signature date on this Agreement or (b) signature date on the Quote (“**Effective Date**”). Axon and Agency are each a “**Party**” and collectively “**Parties**”. This Agreement governs Agency’s purchase and use of the Axon Devices and Services detailed in the Quote Appendix (“**Quote**”). It is the intent of the Parties that this Agreement act as a master agreement governing all subsequent purchases by Agency for the same Axon products and services in the Quote, and all such subsequent quotes accepted by Agency shall be also incorporated into this Agreement by reference as a Quote. The Parties therefore agree as follows:

**1** **Definitions.**

“**Axon Cloud Services**” means Axon’s web services for Axon Evidence, Axon Records, Axon Dispatch, and interactions between Evidence.com and Axon Devices or Axon client software. Axon Cloud Service excludes third-party applications, hardware warranties, and my.evidence.com.

“**Axon Device**” means all hardware provided by Axon under this Agreement.

“**Quote**” means an offer to sell and is only valid for devices and services on the quote at the specified prices. Any terms within Agency’s purchase order in response to a Quote will be void. Orders are subject to prior credit approval. Changes in the deployment estimated ship date may change charges in the Quote. Shipping dates are estimates only. Axon is not responsible for typographical errors in any offer by Axon, and Axon reserves the right to cancel any orders resulting from such errors.

“**Services**” means all services provided by Axon under this Agreement, including software, Axon Cloud Services, and professional services.

**2** **Term.** This Agreement begins on the Effective Date and continues until all subscriptions hereunder have expired or have been terminated (“**Term**”).

All subscriptions including Axon Evidence, Axon Fleet, Officer Safety Plans, Technology Assurance Plans, and TASER 7 plans begin after shipment of the applicable Axon Device. If Axon ships the Axon Device in the first half of the month, the start date is the 1st of the following month. If Axon ships the Axon Device in the second half of the month, the start date is the 15th of the following month. For purchases solely of Axon Evidence subscriptions, the start date is the Effective Date. Each subscription term ends upon completion of the subscription stated in the Quote (“**Subscription Term**”).

Upon completion of the Subscription Term, the Subscription Term will automatically renew for an additional 5 years (“**Renewal Term**”). For purchase of TASER 7 as a standalone, Axon may increase pricing to its then-current list pricing for any Renewal Term. For all other purchases, Axon may increase pricing on all line items in the Quote up to 3% at the beginning of each year of the Renewal Term. New devices and services may require additional terms. Axon will not authorize services until Axon receives a signed Quote or accepts a purchase order, whichever is first.

**3** **Payment.** Axon invoices upon shipment. Payment is due net 30 days from the invoice date. Payment obligations are non-cancelable. Agency will pay invoices without setoff, deduction, or withholding. If Axon sends a past due account to collections, Agency is responsible for collection and attorneys’ fees.

**4** **Taxes.** Agency is responsible for sales and other taxes associated with the order unless Agency provides Axon a valid tax exemption certificate.

**5** **Shipping.** Axon may make partial shipments and ship Axon Devices from multiple locations. All shipments are FOB shipping point via common carrier. Title and risk of loss pass to Agency upon Axon’s delivery to the common carrier. Agency is responsible for any shipping charges in the Quote.

**6** **Returns.** All sales are final. Axon does not allow refunds or exchanges, except warranty returns or as provided by state or federal law.

---

Title: Master Services and Purchasing Agreement between Axon and Agency (Online)

Department: Legal

Version: 1.0

Release Date: 3/31/2021

Page 1 of 47



7 **Warranty.**

7.1 **Hardware Limited Warranty.** Axon warrants that Axon-manufactured Devices are free from defects in workmanship and materials for 1 year from the date of Agency's receipt, except Signal Sidearm, which Axon warrants for 30 months from the date of Agency's receipt. Axon warrants its Axon-manufactured accessories for 90-days from the date of Agency's receipt. Used conducted energy weapon ("CEW") cartridges are deemed to have operated properly. Extended warranties run from the expiration of the 1-year hardware warranty through the extended warranty term. Non-Axon manufactured Devices are not covered by Axon's warranty. Agency should contact the manufacturer for support of non-Axon manufactured Devices.

7.2 **Claims.** If Axon receives a valid warranty claim for an Axon manufactured Device during the warranty term, Axon's sole responsibility is to repair or replace the Device with the same or like Device, at Axon's option. A replacement Axon Device will be new or like new. Axon will warrant the replacement Axon Device for the longer of (a) the remaining warranty of the original Axon Device or (b) 90-days from the date of repair or replacement.

If Agency exchanges a device or part, the replacement item becomes Agency's property, and the replaced item becomes Axon's property. Before delivering a Axon Device for service, Agency must upload Axon Device data to Axon Evidence or download it and retain a copy. Axon is not responsible for any loss of software, data, or other information contained in storage media or any part of the Axon Device sent to Axon for service.

7.3 **Spare Axon Devices.** For qualified purchases, Axon may provide Agency a predetermined number of spare Axon Devices as detailed in the Quote ("**Spare Axon Devices**"). Spare Axon Devices are intended to replace broken or non-functioning units while Agency submits the broken or non-functioning units, through Axon's warranty return process. Axon will repair or replace the unit with a replacement Axon Device. Title and risk of loss for all Spare Axon Devices shall pass to Agency in accordance with shipping terms under Section 5. Axon assumes no liability or obligation in the event Agency does not utilize Spare Axon Devices for the intended purpose.

7.4 **Limitations.** Axon's warranty excludes damage related to: (a) failure to follow Axon Device use instructions; (b) Axon Devices used with equipment not manufactured or recommended by Axon; (c) abuse, misuse, or intentional damage to Axon Device; (d) force majeure; (e) Axon Devices repaired or modified by persons other than Axon without Axon's written permission; or (f) Axon Devices with a defaced or removed serial number.

7.4.1 **To the extent permitted by law, the above warranties and remedies are exclusive. Axon disclaims all other warranties, remedies, and conditions, whether oral, written, statutory, or implied. If statutory or implied warranties cannot be lawfully disclaimed, then such warranties are limited to the duration of the warranty described above and by the provisions in this Agreement.**

7.4.2 **Axon's cumulative liability to any Party for any loss or damage resulting from any claim, demand, or action arising out of or relating to any Axon Device or Service will not exceed the purchase price paid to Axon for the Axon Device, or if for Services, the amount paid for such Services over the 12 months preceding the claim. Neither Party will be liable for direct, special, indirect, incidental, punitive or consequential damages, however caused, whether for breach of warranty or contract, negligence, strict liability, tort or any other legal theory.**

8 **Statement of Work.** Certain Axon Devices and Services, including Axon Interview Room, Axon Channel Services, and Axon Fleet, may require a Statement of Work that details Axon's Service deliverables ("**SOW**"). In the event Axon provides an SOW to Agency, Axon is only responsible to perform Services described in the SOW. Additional services are out of scope. The Parties must document scope changes in a written and signed change order. Changes may require an equitable adjustment in fees or schedule. The SOW is incorporated into this Agreement by reference.

9 **Axon Device Warnings.** See [www.axon.com/legal](http://www.axon.com/legal) for the most current Axon Device warnings.



## Master Services and Purchasing Agreement between Axon and Agency (Online)

- 10 **Design Changes.** Axon may make design changes to any Axon Device or Service without notifying Agency or making the same change to Axon Devices and Services previously purchased by Agency.
- 11 **Bundled Offerings.** Some offerings in bundled offerings may not be generally available at the time of Agency's purchase. Axon will not provide a refund, credit, or additional discount beyond what is in the Quote due to a delay of availability or Agency's election not to utilize any portion of an Axon bundle.
- 12 **Insurance.** Axon will maintain General Liability, Workers' Compensation, and Automobile Liability insurance. Upon request, Axon will supply certificates of insurance.
- 13 **Indemnification.** Axon will indemnify Agency's officers, directors, and employees ("Agency Indemnitees") against all claims, demands, losses, and reasonable expenses arising out of a third-party claim against an Agency Indemnitee resulting from any negligent act, error or omission, or willful misconduct by Axon under this Agreement, except to the extent of Agency's negligence or willful misconduct, or claims under workers compensation.
- 14 **IP Rights.** Axon owns and reserves all right, title, and interest in Axon devices and services and suggestions to Axon, including all related intellectual property rights. Agency will not cause any Axon proprietary rights to be violated.
- 15 **IP Indemnification.** Axon will indemnify Agency Indemnitees against all claims, losses, and reasonable expenses from any third-party claim alleging that the use of Axon Devices or Services infringes or misappropriates the third-party's intellectual property rights. Agency must promptly provide Axon with written notice of such claim, tender to Axon the defense or settlement of such claim at Axon's expense and cooperate fully with Axon in the defense or settlement of such claim. Axon's IP indemnification obligations do not apply to claims based on (a) modification of Axon Devices or Services by Agency or a third-party not approved by Axon; (b) use of Axon Devices and Services in combination with hardware or services not approved by Axon; (c) use of Axon Devices and Services other than as permitted in this Agreement; or (d) use of Axon software that is not the most current release provided by Axon.
- 16 **Agency Responsibilities.** Agency is responsible for (a) Agency's use of Axon Devices; (b) breach of this Agreement or violation of applicable law by Agency or an Agency end user; and (c) a dispute between Agency and a third-party over Agency's use of Axon Devices.
- 17 **Termination.**
- 17.1 **For Breach.** A Party may terminate this Agreement for cause if it provides 30 days written notice of the breach to the other Party, and the breach remains uncured at the end of 30 days. If Agency terminates this Agreement due to Axon's uncured breach, Axon will refund prepaid amounts on a prorated basis based on the effective date of termination.
- 17.2 **By Agency.** If sufficient funds are not appropriated or otherwise legally available to pay the fees, Agency may terminate this Agreement. Agency will deliver notice of termination under this section as soon as reasonably practicable.
- 17.3 **Effect of Termination.** Upon termination of this Agreement, Agency rights immediately terminate. Agency remains responsible for all fees incurred before the effective date of termination. If Agency purchases Axon Devices for less than the manufacturer's suggested retail price ("**MSRP**") and this Agreement terminates before the end of the Term, Axon will invoice Agency the difference between the MSRP for Axon Devices received, including any Spare Axon Devices, and amounts paid towards those Axon Devices. Only if terminating for non-appropriation, Agency may return Axon Devices to Axon within 30 days of termination. MSRP is the standalone price of the individual Axon Device at the time of sale. For bundled Axon Devices, MSRP is the standalone price of all individual components.
- 18 **Confidentiality.** "**Confidential Information**" means nonpublic information designated as confidential or, given the nature of the information or circumstances surrounding disclosure, should reasonably be

understood to be confidential. Each Party will take reasonable measures to avoid disclosure, dissemination, or unauthorized use of the other Party's Confidential Information. Unless required by law, neither Party will disclose the other Party's Confidential Information during the Term and for 5-years thereafter. Axon pricing is Confidential Information and competition sensitive. If Agency is required by law to disclose Axon pricing, to the extent allowed by law, Agency will provide notice to Axon before disclosure. Axon may publicly announce information related to this Agreement.

**19** **General.**

**19.1 Force Majeure.** Neither Party will be liable for any delay or failure to perform due to a cause beyond a Party's reasonable control.

**19.2 Independent Contractors.** The Parties are independent contractors. Neither Party has the authority to bind the other. This Agreement does not create a partnership, franchise, joint venture, agency, fiduciary, or employment relationship between the Parties.

**19.3 Third-Party Beneficiaries.** There are no third-party beneficiaries under this Agreement.

**19.4 Non-Discrimination.** Neither Party nor its employees will discriminate against any person based on race; religion; creed; color; sex; gender identity and expression; pregnancy; childbirth; breastfeeding; medical conditions related to pregnancy, childbirth, or breastfeeding; sexual orientation; marital status; age; national origin; ancestry; genetic information; disability; veteran status; or any class protected by local, state, or federal law.

**19.5 Export Compliance.** Each Party will comply with all import and export control laws and regulations.

**19.6 Assignment.** Neither Party may assign this Agreement without the other Party's prior written consent. Axon may assign this Agreement, its rights, or obligations without consent: (a) to an affiliate or subsidiary; or (b) for purposes of financing, merger, acquisition, corporate reorganization, or sale of all or substantially all its assets. This Agreement is binding upon the Parties respective successors and assigns.

**19.7 Waiver.** No waiver or delay by either Party in exercising any right under this Agreement constitutes a waiver of that right.

**19.8 Severability.** If a court of competent jurisdiction holds any portion of this Agreement invalid or unenforceable, the remaining portions of this Agreement will remain in effect.

**19.9 Survival.** The following sections will survive termination: Payment, Warranty, Axon Device Warnings, Indemnification, IP Rights, and Agency Responsibilities.

**19.10 Governing Law.** The laws of the state where Agency is physically located, without reference to conflict of law rules, govern this Agreement and any dispute arising from it. The United Nations Convention for the International Sale of Goods does not apply to this Agreement.

**19.11 Notices.** All notices must be in English. Notices posted on Agency's Axon Evidence site are effective upon posting. Notices by email are effective on the sent date of the email. Notices by personal delivery are effective immediately. Contact information for notices:

Axon: Axon Enterprise, Inc.  
Attn: Legal  
17800 N. 85th Street  
Scottsdale, Arizona 85255  
legal@axon.com

Agency:  
Attn:  
Street Address  
City, State, Zip  
Email

**19.12 Entire Agreement.** This Agreement, including the Appendices and any SOW(s), represents the entire agreement between the Parties. This Agreement supersedes all prior agreements or

---

---

understandings, whether written or verbal, regarding the subject matter of this Agreement. This Agreement may only be modified or amended in a writing signed by the Parties.

Each representative identified below declares they have been expressly authorized to execute this Agreement as of the date of signature.

**Axon Enterprise, Inc.**

**Agency**

Signature: \_\_\_\_\_

Signature: \_\_\_\_\_

Name: \_\_\_\_\_

Name: \_\_\_\_\_

Title: \_\_\_\_\_

Title: \_\_\_\_\_

Date: \_\_\_\_\_

Date: \_\_\_\_\_

---

**Axon Cloud Services Terms of Use Appendix**

**1** **Definitions.**

**“Agency Content”** is data uploaded into, ingested by, or created in Axon Cloud Services within Agency’s tenant, including media or multimedia uploaded into Axon Cloud Services by Agency. Agency Content includes Evidence but excludes Non-Content Data.

**“Evidence”** is media or multimedia uploaded into Axon Evidence as ‘evidence’ by an Agency. Evidence is a subset of Agency Content.

**“Non-Content Data”** is data, configuration, and usage information about Agency’s Axon Cloud Services tenant, Axon Devices and client software, and users that is transmitted or generated when using Axon Devices. Non-Content Data includes data about users captured during account management and customer support activities. Non-Content Data does not include Agency Content.

**“Personal Data”** means any information relating to an identified or identifiable natural person. An identifiable natural person is one who can be identified, directly or indirectly, in particular by reference to an identifier such as a name, an identification number, location data, an online identifier or to one or more factors specific to the physical, physiological, genetic, mental, economic, cultural or social identity of that natural person.

**2** **Access.** Upon Axon granting Agency a subscription to Axon Cloud Services, Agency may access and use Axon Cloud Services to store and manage Agency Content. Agency may not exceed more end users than the Quote specifies. Axon Air requires an Axon Evidence subscription for each drone operator. For Axon Evidence Lite, Agency may access and use Axon Evidence only to store and manage TASER CEW and TASER CAM data (**“TASER Data”**). Agency may not upload non-TASER Data to Axon Evidence Lite.

**3** **Agency Owns Agency Content.** Agency controls and owns all right, title, and interest in Agency Content. Except as outlined herein, Axon obtains no interest in Agency Content, and Agency Content is not Axon’s business records. Agency is solely responsible for uploading, sharing, managing, and deleting Agency Content. Axon will only have access to Agency Content for the limited purposes set forth herein. Agency agrees to allow Axon access to Agency Content to (a) perform troubleshooting, maintenance, or diagnostic screenings; and (b) enforce this Agreement or policies governing use of the Axon products.

**4** **Security.** Axon will implement commercially reasonable and appropriate measures to secure Agency Content against accidental or unlawful loss, access or disclosure. Axon will maintain a comprehensive information security program to protect Axon Cloud Services and Agency Content including logical, physical access, vulnerability, risk, and configuration management; incident monitoring and response; encryption of uploaded digital evidence; security education; and data protection. Axon agrees to the Federal Bureau of Investigation Criminal Justice Information Services Security Addendum.

**5** **Agency Responsibilities.** Agency is responsible for (a) ensuring Agency owns Agency Content; (b) ensuring no Agency Content or Agency end user’s use of Agency Content or Axon Cloud Services violates this Agreement or applicable laws; and (c) maintaining necessary computer equipment and Internet connections for use of Axon Cloud Services. If Agency becomes aware of any violation of this Agreement by an end user, Agency will immediately terminate that end user’s access to Axon Cloud Services.

Agency will also maintain the security of end user names and passwords and security and access by end users to Agency Content. Agency is responsible for ensuring the configuration and utilization of Axon Cloud Services meet applicable Agency regulation and standards. Agency may not sell, transfer, or sublicense access to any other entity or person. Agency shall contact Axon immediately





## Master Services and Purchasing Agreement between Axon and Agency (Online)

if an unauthorized party may be using Agency's account or Agency Content, or if account information is lost or stolen.

To the extent Agency uses the Axon Cloud Services to interact with YouTube®, such use may be governed by the YouTube Terms of Service, available at <https://www.youtube.com/static?template=terms>.

- 6 **Privacy.** Agency's use of Axon Cloud Services is subject to the Axon Cloud Services Privacy Policy, a current version of which is available at <https://www.axon.com/legal/cloud-services-privacy-policy>. Agency agrees to allow Axon access to Non-Content Data from Agency to (a) perform troubleshooting, maintenance, or diagnostic screenings; (b) provide, develop, improve, and support current and future Axon products and related services; and (c) enforce this Agreement or policies governing the use of Axon products.
- 7 **Axon Body 3 Wi-Fi Positioning.** Axon Body 3 cameras offer a feature to enhance location services where GPS/GNSS signals may not be available, for instance, within buildings or underground. Agency administrators can manage their choice to use this service within the administrative features of Axon Cloud Services. If Agency chooses to use this service, Axon must also enable the usage of the feature for Agency's Axon Cloud Services tenant. Agency will not see this option with Axon Cloud Services unless Axon has enabled Wi-Fi Positioning for Agency's Axon Cloud Services tenant. When Wi-Fi Positioning is enabled by both Axon and Agency, Non-Content and Personal Data will be sent to Skyhook Holdings, Inc. ("**Skyhook**") to facilitate the Wi-Fi Positioning functionality. Data controlled by Skyhook is outside the scope of the Axon Cloud Services Privacy Policy and is subject to the Skyhook Services Privacy Policy.
- 8 **Storage.** For Axon Unlimited Device Storage subscriptions, Agency may store unlimited data in Agency's Axon Evidence account only if data originates from Axon Capture or the applicable Axon Device. Axon may charge Agency additional fees for exceeding purchased storage amounts. Axon may place Agency Content that Agency has not viewed or accessed for 6 months into archival storage. Agency Content in archival storage will not have immediate availability and may take up to 24 hours to access.
- 9 **Location of Storage.** Axon may transfer Agency Content to third-party subcontractors for storage. Axon will determine the locations of data centers for storage of Agency Content. For United States agencies, Axon will ensure all Agency Content stored in Axon Cloud Services remains within the United States. Ownership of Agency Content remains with Agency.
- 10 **Suspension.** Axon may temporarily suspend Agency's or any end user's right to access or use any portion or all of Axon Cloud Services immediately upon notice, if Agency or end user's use of or registration for Axon Cloud Services may (a) pose a security risk to Axon Cloud Services or any third-party; (b) adversely impact Axon Cloud Services, the systems, or content of any other customer; (c) subject Axon, Axon's affiliates, or any third-party to liability; or (d) be fraudulent.  
  
Agency remains responsible for all fees incurred through suspension. Axon will not delete Agency Content because of suspension, except as specified in this Agreement.
- 11 **Axon Cloud Services Warranty.** Axon disclaims any warranties or responsibility for data corruption or errors before Agency uploads data to Axon Cloud Services.
- 12 **Axon Records.** Axon Records is the software-as-a-service product that is generally available at the time Agency purchases an OSP 7 bundle. During Agency's Axon Records Subscription Term, Agency will be entitled to receive Axon's Update and Upgrade releases on an if-and-when available basis.

The Axon Records Subscription Term will end upon the competition of the Axon Records Subscription as documented in the Quote, or if purchased as part of an OSP 7 bundle, upon

Title: Master Services and Purchasing Agreement between Axon and Agency (Online)

competition of the OSP 7 Term (“**Axon Records Subscription**”)

An “**Update**” is a generally available release of Axon Records that Axon makes available from time to time. An “**Upgrade**” includes (i) new versions of Axon Records that enhance features and functionality, as solely determined by Axon; and/or (ii) new versions of Axon Records that provide additional features or perform additional functions. Upgrades exclude new products that Axon introduces and markets as distinct products or applications.

New or additional Axon products and applications, as well as any Axon professional services needed to configure Axon Records, are not included. If Agency purchases Axon Records as part of a bundled offering, the Axon Record subscription begins on the later of the (1) start date of that bundled offering, or (2) date Axon provisions Axon Records to Agency.

- 13** **Axon Cloud Services Restrictions.** Agency and Agency end users (including employees, contractors, agents, officers, volunteers, and directors), may not, or may not attempt to:
- 13.1** copy, modify, tamper with, repair, or create derivative works of any part of Axon Cloud Services;
  - 13.2** reverse engineer, disassemble, or decompile Axon Cloud Services or apply any process to derive any source code included in Axon Cloud Services, or allow others to do the same;
  - 13.3** access or use Axon Cloud Services with the intent to gain unauthorized access, avoid incurring fees or exceeding usage limits or quotas;
  - 13.4** use trade secret information contained in Axon Cloud Services, except as expressly permitted in this Agreement;
  - 13.5** access Axon Cloud Services to build a competitive device or service or copy any features, functions, or graphics of Axon Cloud Services;
  - 13.6** remove, alter, or obscure any confidentiality or proprietary rights notices (including copyright and trademark notices) of Axon’s or Axon’s licensors on or within Axon Cloud Services; or
  - 13.7** use Axon Cloud Services to store or transmit infringing, libelous, or other unlawful or tortious material; to store or transmit material in violation of third-party privacy rights; or to store or transmit malicious code.
- 14** **After Termination.** Axon will not delete Agency Content for 90-days following termination. There will be no functionality of Axon Cloud Services during these 90-days other than the ability to retrieve Agency Content. Agency will not incur additional fees if Agency downloads Agency Content from Axon Cloud Services during this time. Axon has no obligation to maintain or provide Agency Content after these 90-days and will thereafter, unless legally prohibited, delete all Agency Content. Upon request, Axon will provide written proof that Axon successfully deleted and fully removed all Agency Content from Axon Cloud Services.
- 15** **Post-Termination Assistance.** Axon will provide Agency with the same post-termination data retrieval assistance that Axon generally makes available to all customers. Requests for Axon to provide additional assistance in downloading or transferring Agency Content, including requests for Axon’s data egress service, will result in additional fees and Axon will not warrant or guarantee data integrity or readability in the external system.
- 16** **U.S. Government Rights.** If Agency is a U.S. Federal department or using Axon Cloud Services on behalf of a U.S. Federal department, Axon Cloud Services is provided as a “commercial item,” “commercial computer software,” “commercial computer software documentation,” and “technical data”, as defined in the Federal Acquisition Regulation and Defense Federal Acquisition Regulation Supplement. If Agency is using Axon Cloud Services on behalf of the U.S. Government and these terms fail to meet the U.S. Government’s needs or are inconsistent in any respect with federal law, Agency will immediately discontinue use of Axon Cloud Services.
- 17** **Survival.** Upon any termination of this Agreement, the following sections in this Appendix will



**Master Services and Purchasing Agreement  
between Axon and Agency (Online)**

---

survive: Agency Owns Agency Content, Storage, Axon Cloud Services Warranty, and Axon Cloud Services Restrictions.

**Professional Services Appendix**

- 1 **Utilization of Services.** Agency must use professional services as outlined in the Quote and this Appendix within 6 months of the Effective Date.
- 2 **Body-Worn Camera Full Service (BWC Full Service).** BWC Full Service includes advance remote project planning and configuration support and up to 4 consecutive days of on-site service and a professional services manager to work with Agency to assess Agency’s deployment and determine which on-site services are appropriate. If Agency requires more than 4 consecutive on-site days, Agency must purchase additional days. BWC Full Service options include:

<p><b>System set up and configuration</b></p> <ul style="list-style-type: none"> <li>• Instructor-led setup of Axon View on smartphones (if applicable)</li> <li>• Configure categories and custom roles based on Agency need</li> <li>• Register cameras to Agency domain</li> <li>• Troubleshoot IT issues with Axon Evidence and Axon Dock (“Dock”) access</li> <li>• One on-site session included</li> </ul>
<p><b>Dock configuration</b></p> <ul style="list-style-type: none"> <li>• Work with Agency to decide the ideal location of Docks and set configurations on Dock</li> <li>• Authenticate Dock with Axon Evidence using admin credentials from Agency</li> <li>• On-site assistance, not to include physical mounting of docks</li> </ul>
<p><b>Best practice implementation planning session</b></p> <ul style="list-style-type: none"> <li>• Provide considerations for the establishment of video policy and system operations best practices based on Axon’s observations with other agencies</li> <li>• Discuss the importance of entering metadata in the field for organization purposes and other best practice for digital data management</li> <li>• Provide referrals of other agencies using the Axon camera devices and Axon Evidence</li> <li>• Recommend rollout plan based on review of shift schedules</li> </ul>
<p><b>System Admin and troubleshooting training sessions</b> Step-by-step explanation and assistance for Agency’s configuration of security, roles &amp; permissions, categories &amp; retention, and other specific settings for Axon Evidence</p>
<p><b>Axon instructor training (Train the Trainer)</b> Training for Agency’s in-house instructors who can support Agency’s Axon camera and Axon Evidence training needs after Axon has fulfilled its contractual on-site obligations</p>
<p><b>Evidence sharing training</b> Tailored workflow instruction for Investigative Units on sharing Cases and Evidence with local prosecuting agencies</p>
<p><b>End user go-live training and support sessions</b></p> <ul style="list-style-type: none"> <li>• Assistance with device set up and configuration</li> <li>• Training on device use, Axon Evidence, and Evidence Sync</li> </ul>
<p><b>Implementation document packet</b> Axon Evidence administrator guides, camera implementation guides, network setup guide, sample policies, and categories &amp; roles guide</p>
<p><b>Post go-live review</b></p>

- 3 **Body-Worn Camera Starter Service (BWC Starter).** BWC Starter includes advance remote project planning and configuration support and one day of on-site Services and a professional services manager to work closely with Agency to assess Agency’s deployment and determine which Services are appropriate. If Agency requires more than 1 day of on-site Services, Agency must purchase additional on-site Services. The BWC Starter options include:



<p><b>System set up and configuration (Remote Support)</b></p> <ul style="list-style-type: none"> <li>• Instructor-led setup of Axon View on smartphones (if applicable)</li> <li>• Configure categories &amp; custom roles based on Agency need</li> <li>• Troubleshoot IT issues with Axon Evidence and Axon Dock (“<b>Dock</b>”) access</li> </ul>
<p><b>Dock configuration</b></p> <ul style="list-style-type: none"> <li>• Work with Agency to decide the ideal location of Dock setup and set configurations on Dock</li> <li>• Authenticate Dock with Axon Evidence using “Administrator” credentials from Agency</li> <li>• Does not include physical mounting of docks</li> </ul>
<p><b>Axon instructor training (Train the Trainer)</b> Training for Agency’s in-house instructors who can support Agency’s Axon camera and Axon Evidence training needs after Axon’s has fulfilled its contracted on-site obligations</p>
<p><b>End user go-live training and support sessions</b></p> <ul style="list-style-type: none"> <li>• Assistance with device set up and configuration</li> <li>• Training on device use, Axon Evidence, and Evidence Sync</li> </ul>
<p><b>Implementation document packet</b> Axon Evidence administrator guides, camera implementation guides, network setup guide, sample policies, and categories &amp; roles guide</p>

**4** **Body-Worn Camera Virtual 1-Day Service (BWC Virtual).** BWC Virtual includes all items in the BWC Starter Service Package, except one day of on-site services.

**5** **CEW Services Packages.** CEW Services Packages are detailed below:

<p><b>System set up and configuration</b></p> <ul style="list-style-type: none"> <li>• Configure Axon Evidence categories &amp; custom roles based on Agency need.</li> <li>• Troubleshoot IT issues with Axon Evidence.</li> <li>• Register users and assign roles in Axon Evidence.</li> <li>• <b>For the CEW Full Service Package:</b> On-site assistance included</li> <li>• <b>For the CEW Starter Package:</b> Virtual assistance included</li> </ul>
<p><b>Dedicated Project Manager</b> Assignment of specific Axon representative for all aspects of planning the rollout (Project Manager). Ideally, Project Manager will be assigned to Agency 4–6 weeks before rollout</p>
<p><b>Best practice implementation planning session to include:</b></p> <ul style="list-style-type: none"> <li>• Provide considerations for the establishment of CEW policy and system operations best practices based on Axon’s observations with other agencies</li> <li>• Discuss the importance of entering metadata and best practices for digital data management</li> <li>• Provide referrals to other agencies using TASER CEWs and Axon Evidence</li> <li>• <b>For the CEW Full Service Package:</b> On-site assistance included</li> <li>• <b>For the CEW Starter Package:</b> Virtual assistance included</li> </ul>
<p><b>System Admin and troubleshooting training sessions</b> On-site sessions providing a step-by-step explanation and assistance for Agency’s configuration of security, roles &amp; permissions, categories &amp; retention, and other specific settings for Axon Evidence</p>
<p><b>Axon Evidence Instructor training</b></p> <ul style="list-style-type: none"> <li>• Provide training on the Axon Evidence to educate instructors who can support Agency’s subsequent Axon Evidence training needs.</li> <li>• <b>For the CEW Full Service Package:</b> Training for up to 3 individuals at Agency</li> <li>• <b>For the CEW Starter Package:</b> Training for up to 1 individual at Agency</li> </ul>
<p><b>TASER CEW inspection and device assignment</b> Axon’s on-site professional services team will perform functions check on all new TASER CEW Smart weapons and assign them to a user on Axon Evidence.</p>





**Post go-live review**

**For the CEW Full Service Package:** On-site assistance included.

**For the CEW Starter Package:** Virtual assistance included.

**6 Smart Weapon Transition Service.** The Smart Weapon Transition Service includes:

**Archival of CEW Firing Logs**

Axon's on-site professional services team will upload CEW firing logs to Axon Evidence from all TASER CEW Smart Weapons that Agency is replacing with newer Smart Weapon models.

**Return of Old Weapons**

Axon's on-site professional service team will ship all old weapons back to Axon's headquarters.

Axon will provide Agency with a Certificate of Destruction

\*Note: CEW Full Service packages for TASER 7 include Smart Weapon Transition Service instead of 1-Day Device Specific Instructor Course.

**7 Signal Sidearm Installation Service.** If Agency purchases Signal Sidearm Installation Service, Axon will provide one day of on-site Services and one professional services manager and will cover the installation of up to 100 Signal Sidearm devices per package purchased. Agency is responsible for providing an appropriate work area and ensuring all holsters that will have Signal Sidearm installed onto them are available on the agreed-upon installation date(s). Installation includes:

Removal of existing connection screws that affix a holster to a holster mount
Proper placement of the Signal Sidearm Mounting Plate between the holster and the mount
Reattachment of the holster to the mount using appropriate screws
Functional testing of Signal Sidearm device

**8 Out of Scope Services.** Axon is only responsible to perform the professional services described in the Quote and this Appendix. Any additional professional services are out of scope. The Parties must document scope changes in a written and signed change order. Changes may require an equitable adjustment in the charges or schedule.

**9 Delivery of Services.** Axon personnel will work Monday through Friday, 8:30 a.m. to 5:30 p.m., except holidays. Axon will perform all on-site tasks over a consecutive timeframe. Axon will not charge Agency travel time by Axon personnel to Agency premises as work hours.

**10 Access Computer Systems to Perform Services.** Agency authorizes Axon to access relevant Agency computers and networks, solely for performing the Services. Axon will work to identify as soon as reasonably practicable resources and information Axon expects to use and will provide an initial itemized list to Agency. Agency is responsible for and assumes the risk of any problems, delays, losses, claims, or expenses resulting from the content, accuracy, completeness, and consistency of all data, materials, and information supplied by Agency.

**11 Site Preparation.** Axon will provide a hardcopy or digital copy of current user documentation for the Axon Devices ("**User Documentation**"). User Documentation will include all required environmental specifications for the professional Services and Axon Devices to operate per the Axon Device User Documentation. Before installation of Axon Devices (whether performed by Agency or Axon), Agency must prepare the location(s) where Axon Devices are to be installed ("**Installation Site**") per the environmental specifications in the Axon Device User Documentation. Following installation, Agency must maintain the Installation Site per the environmental specifications. If Axon modifies Axon Device User Documentation for any Axon Devices under this Agreement, Axon will provide the update to Agency when Axon generally releases it

**12 Acceptance.** When Axon completes professional Services, Axon will present an acceptance form ("**Acceptance Form**") to Agency. Agency will sign the Acceptance Form acknowledging completion. If Agency reasonably believes Axon did not complete the professional Services in



## Master Services and Purchasing Agreement between Axon and Agency (Online)

---

substantial conformance with this Agreement, Agency must notify Axon in writing of the specific reasons for rejection within 7 calendar days from delivery of the Acceptance Form. Axon will address the issues and re-present the Acceptance Form for signature. If Axon does not receive the signed Acceptance Form or written notification of reasons for rejection within 7 calendar days of delivery of the Acceptance Form, Axon will deem Agency to have accepted the professional Services.

- 13 **Agency Network**. For work performed by Axon transiting or making use of Agency's network, Agency is solely responsible for maintenance and functionality of the network. In no event will Axon be liable for loss, damage, or corruption of Agency's network from any cause.



---

## Technology Assurance Plan Appendix

If Technology Assurance Plan (“TAP”) or a bundle including TAP is on the Quote, this appendix applies.

- 1 **TAP Warranty.** The TAP warranty is an extended warranty that starts at the end of the 1-year Hardware Limited Warranty.
- 2 **Officer Safety Plan.** If Agency purchases an Officer Safety Plan (“OSP”), Agency will receive the deliverables detailed in the Quote. Agency must accept delivery of the TASER CEW and accessories as soon as available from Axon.
- 3 **OSP 7 Term.** OSP 7 begins after Axon ships the Axon Body 3 or TASER 7 hardware to Agency. If Axon ships in the first half of the month, OSP 7 starts the 1st of the following month. If Axon ships in the second half of the month, OSP 7 starts the 15th of the following month (“**OSP 7 Term**”).
- 4 **TAP BWC Upgrade.** If Agency has no outstanding payment obligations and purchased TAP, Axon will provide Agency a new Axon body-worn camera (“**BWC Upgrade**”) as scheduled in the Quote. If Agency purchased TAP Axon will provide a BWC Upgrade that is the same or like Axon Device, at Axon’s option. Axon makes no guarantee the BWC Upgrade will utilize the same accessories or Axon Dock.
- 5 **TAP Dock Upgrade.** If Agency has no outstanding payment obligations and purchased TAP, Axon will provide Agency a new Axon Dock as scheduled in the Quote (“**Dock Upgrade**”). Accessories associated with any Dock Upgrades are subject to change at Axon discretion. Dock Upgrades will only include a new Axon Dock bay configuration unless a new Axon Dock core is required for BWC compatibility. If Agency originally purchased a single-bay Axon Dock, the Dock Upgrade will be a single-bay Axon Dock model that is the same or like Axon Device, at Axon’s option. If Agency originally purchased a multi-bay Axon Dock, the Dock Upgrade will be a multi-bay Axon Dock that is the same or like Axon Device, at Axon’s option.
- 6 **Upgrade Delay.** Axon may ship the BWC and Dock Upgrades as scheduled in the Quote without prior confirmation from Agency unless the Parties agree in writing otherwise at least 90 days in advance. Axon may ship the final BWC and Dock Upgrade as scheduled in the Quote 60 days before the end of the Subscription Term without prior confirmation from Agency.
- 7 **Upgrade Change.** If Agency wants to change Axon Device models for the offered BWC or Dock Upgrade, Agency must pay the price difference between the MSRP for the offered BWC or Dock Upgrade and the MSRP for the model desired. If the model Agency desires has an MSRP less than the MSRP of the offered BWC Upgrade or Dock Upgrade, Axon will not provide a refund. The MSRP is the MSRP in effect at the time of the upgrade.
- 8 **Return of Original Axon Device.** Within 30 days of receiving a BWC or Dock Upgrade, Agency must return the original Axon Devices to Axon or destroy the Axon Devices and provide a certificate of destruction to Axon including serial numbers for the destroyed Axon Devices. If Agency does not return or destroy the Axon Devices, Axon will deactivate the serial numbers for the Axon Devices received by Agency.
- 9 **Termination.** If Agency’s payment for TAP, OSP, or Axon Evidence is more than 30 days past due, Axon may terminate TAP or OSP. Once TAP or OSP terminates for any reason:
  - 9.1 TAP and OSP coverage terminate as of the date of termination and no refunds will be given.
  - 9.2 Axon will not and has no obligation to provide the Upgrade Models.
  - 9.3 Agency must make any missed payments due to the termination before Agency may purchase any future TAP or OSP.

### TASER 7 Appendix



# Master Services and Purchasing Agreement between Axon and Agency (Online)

This TASER 7 Appendix applies to Agency's TASER 7, OSP 7, or OSP 7 Plus purchase from Axon.

- 1 **Duty Cartridge Replenishment Plan.** If the Quote includes “**Duty Cartridge Replenishment Plan**”, Agency must purchase the plan for each CEW user. A CEW user includes officers that use a CEW in the line of duty and those that only use a CEW for training. Agency may not resell cartridges received. Axon will only replace cartridges used in the line of duty.
- 2 **Training.** If the Quote includes a training voucher, Agency must use the voucher within 1 year of issuance, or the voucher will be void. Axon will issue Agency a voucher annually beginning on the start of the TASER Subscription Term. The voucher has no cash value. Agency cannot exchange it for another device or service. Unless stated in the Quote, the voucher does not include travel expenses and will be Agency’s responsibility. If the Quote includes Axon Online Training or Virtual Reality Content Empathy Development for Autism/Schizophrenia (collectively, “**Training Content**”), Agency may access Training Content. Axon will deliver all Training Content electronically.
- 3 **Extended Warranty.** If the Quote includes an extended warranty, the extended warranty coverage period warranty will be for a 5-year term, which includes the hardware manufacturer’s warranty plus the 4-year extended term.
- 4 **Trade-in.** If the Quote contains a discount on CEW-related line items, including items related to OSP, then that discount may only be applied as a trade-in credit, and Agency must return used hardware and accessories associated with the discount (“**Trade-In Units**”) to Axon. Agency must ship batteries via ground shipping. Axon will pay shipping costs of the return. If Axon does not receive Trade-In Units within the timeframe below, Axon will invoice Agency the value of the trade-in credit. Agency may not destroy Trade-In Units and receive a trade-in credit.

Agency Size	Days to Return from Start Date of TASER 7 Subscription
Less than 100 officers	30 days
100 to 499 officers	90 days
500+ officers	180 days

- 5 **TASER 7 Subscription Term.** The TASER 7 Subscription Term for a standalone TASER 7 purchase begins on shipment of the TASER 7 hardware. The TASER 7 Subscription Term for OSP 7 begins on the OSP 7 Start date.
- 6 **Access Rights.** Upon Axon granting Agency a TASER 7 Axon Evidence subscription, Agency may access and use Axon Evidence for the storage and management of data from TASER 7 CEW devices during the TASER 7 Subscription Term. Agency may not upload any non-TASER 7 data or any other files to Axon Evidence. Agency may not exceed the number of end users than the Quote specifies.
- 7 **Privacy.** Axon will not disclose Agency Content or any information about Agency except as compelled by a court or administrative body or required by any law or regulation. Axon will give notice if any disclosure request is received for Agency Content, so Agency may file an objection with the court or administrative body.
- 8 **Termination.** If payment for TASER 7 is more than 30 days past due, Axon may terminate Agency’s TASER 7 plan by notifying Agency. Upon termination for any reason, then as of the date of termination:
  - 8.1 TASER 7 extended warranties and access to Training Content will terminate. No refunds will be given.



## Master Services and Purchasing Agreement between Axon and Agency (Online)

---

- 8.2** Axon will invoice Agency the remaining MSRP for TASER 7 products received before termination. If terminating for non-appropriations, Axon will not invoice Agency if Agency returns the CEW, rechargeable battery, holster, dock, core, training suits, and unused cartridges to Axon within 30 days of the date of termination.
- 8.3** Agency will be responsible for payment of any missed payments due to the termination before being allowed to purchase any future TASER 7 plan.

---

**Axon Auto-Tagging Appendix**

- 1 **Scope.** Axon Auto-Tagging consists of the development of a module to allow Axon Evidence to interact with Agency’s Computer-Aided Dispatch (“**CAD**”) or Records Management Systems (“**RMS**”). This allows end users to auto-populate Axon video meta-data with a case ID, category, and location-based on data maintained in Agency’s CAD or RMS.
  
- 2 **Support.** For thirty days after completing Auto-Tagging Services, Axon will provide up to 5 hours of remote support at no additional charge. Axon will provide free support due to a change in Axon Evidence, so long as long as Agency maintains an Axon Evidence and Auto-Tagging subscription. Axon will not provide support if a change is required because Agency changes its CAD or RMS.
  
- 3 **Changes.** Axon is only responsible to perform the Services in this Appendix. Any additional Services are out of scope. The Parties must document scope changes in a written and signed change order. Changes may require an equitable adjustment in fees or schedule.
  
- 4 **Agency Responsibilities.** Axon’s performance of Auto-Tagging Services requires Agency to:
  - 4.1 Make available relevant systems, including Agency’s current CAD or RMS, for assessment by Axon (including remote access if possible);
  - 4.2 Make required modifications, upgrades or alterations to Agency’s hardware, facilities, systems and networks related to Axon’s performance of Auto-Tagging Services;
  - 4.3 Provide access to the premises where Axon is performing Auto-Tagging Services, subject to Agency safety and security restrictions, and allow Axon to enter and exit the premises with laptops and materials needed to perform Auto-Tagging Services;
  - 4.4 Provide all infrastructure and software information (TCP/IP addresses, node names, network configuration) necessary for Axon to provide Auto-Tagging Services;
  - 4.5 Promptly install and implement any software updates provided by Axon;
  - 4.6 Ensure that all appropriate data backups are performed;
  - 4.7 Provide assistance, participation, and approvals in testing Auto-Tagging Services;
  - 4.8 Provide Axon with remote access to Agency’s Axon Evidence account when required;
  - 4.9 Notify Axon of any network or machine maintenance that may impact the performance of the module at Agency; and
  - 4.10 Ensure reasonable availability of knowledgeable staff and personnel to provide timely, accurate, complete, and up-to-date documentation and information to Axon.
  
- 5 **Access to Systems.** Agency authorizes Axon to access Agency’s relevant computers, network systems, and CAD or RMS solely for performing Auto-Tagging Services. Axon will work diligently to identify as soon as reasonably practicable resources and information Axon expects to use and will provide an initial list to Agency. Agency is responsible for and assumes the risk of any problems, delays, losses, claims, or expenses resulting from the content, accuracy, completeness, and consistency of all data, materials, and information supplied by Agency.



---

**Axon Fleet Appendix**

- 1 **Agency Responsibilities.** Agency must ensure its infrastructure and vehicles adhere to the minimum requirements to operate Axon Fleet 2 or Axon Fleet 3 (collectively, "Axon Fleet") as established by Axon during the qualifier call and on-site assessment at Agency and in any technical qualifying questions. If Agency's representations are inaccurate, the Quote is subject to change.
- 2 **Cradlepoint.** If Agency purchases Cradlepoint Enterprise Cloud Manager, Agency will comply with Cradlepoint's end user license agreement. The term of the Cradlepoint license may differ from the Axon Evidence Subscription. If Agency requires Cradlepoint support, Agency will contact Cradlepoint directly.
- 3 **Third-party Installer.** Axon will not be liable for the failure of Axon Fleet hardware to operate per specifications if such failure results from installation not performed by, or as directed by Axon.
- 4 **Wireless Offload Server.**
  - 4.1 **License Grant.** Axon grants Agency a non-exclusive, royalty-free, worldwide, perpetual license to use Wireless Offload Server ("**WOS**"). "Use" means storing, loading, installing, or executing WOS solely for data communication with Axon Devices for the number of licenses purchased. The WOS term begins upon the start of the Axon Evidence Subscription.
  - 4.2 **Restrictions.** Agency may not: (a) modify, alter, tamper with, repair, or create derivative works of WOS; (b) reverse engineer, disassemble, or decompile WOS, apply any process to derive the source code of WOS, or allow others to do so; (c) access or use WOS to avoid incurring fees or exceeding usage limits; (d) copy WOS in whole or part; (e) use trade secret information contained in WOS; (f) resell, rent, loan or sublicense WOS; (g) access WOS to build a competitive device or service or copy any features, functions or graphics of WOS; or (h) remove, alter or obscure any confidentiality or proprietary rights notices (including copyright and trademark notices) of Axon or Axon's licensors on or within WOS.
  - 4.3 **Updates.** If Agency purchases WOS maintenance, Axon will make updates and error corrections to WOS ("**WOS Updates**") available electronically via the Internet or media as determined by Axon. Agency is responsible for establishing and maintaining adequate Internet access to receive WOS Updates and maintaining computer equipment necessary for use of WOS. The Quote will detail the maintenance term.
  - 4.4 **WOS Support.** Upon request by Axon, Agency will provide Axon with access to Agency's store and forward servers solely for troubleshooting and maintenance.
- 5 **Axon Vehicle Software.**
  - 5.1 **License Grant.** Axon grants Agency a non-exclusive, royalty-free, worldwide, perpetual license to use ViewXL or Dashboard (collectively, "Axon Vehicle Software".) "Use" means storing, loading, installing, or executing Axon Vehicle Software solely for data communication with Axon Devices. The Axon Vehicle Software term begins upon the start of the Axon Evidence Subscription.
  - 5.2 **Restrictions.** Agency may not: (a) modify, alter, tamper with, repair, or create derivative works of Axon Vehicle Software; (b) reverse engineer, disassemble, or decompile Axon Vehicle Software, apply any process to derive the source code of Axon Vehicle Software, or allow others to do so; (c) access or use Axon Vehicle Software to avoid incurring fees or exceeding usage limits; (d) copy Axon Vehicle Software in whole or part; (e) use trade secret information contained in Axon Vehicle Software; (f) resell, rent, loan or sublicense Axon Vehicle Software; (g) access Axon Vehicle Software to build a competitive device or service or copy any features, functions or graphics of Axon Vehicle Software; or (h)



## Master Services and Purchasing Agreement between Axon and Agency (Online)

remove, alter or obscure any confidentiality or proprietary rights notices (including copyright and trademark notices) of Axon or Axon's licensors on or within Axon Vehicle Software.

- 6 **Axon Fleet Upgrade.** If Agency has no outstanding payment obligations and has purchased the "Fleet Technology Assurance Plan" (Fleet TAP), Axon will provide Agency with the same or like model of Fleet hardware ("Fleet Upgrade") as schedule on the Quote.

If Agency would like to change models for the Axon Fleet Upgrade, Agency must pay the difference between the MSRP for the offered Axon Fleet Upgrade and the MSRP for the model desired. The MSRP is the MSRP in effect at the time of the upgrade. Agency is responsible for the removal of previously installed hardware and installation of the Axon Fleet Upgrade.

Within 30 days of receiving the Axon Fleet Upgrade, Agency must return the original Axon Devices to Axon or destroy the Axon Devices and provide a certificate of destruction to Axon, including serial numbers of the destroyed Axon Devices. If Agency does not destroy or return the Axon Devices to Axon, Axon will deactivate the serial numbers for the Axon Devices received by Agency.

- 7 **Privacy.** Axon will not disclose Agency Content or any information about Agency except as compelled by a court or administrative body or required by any law or regulation. Axon will give notice if any disclosure request is received for Agency Content, so Agency may file an objection with the court or administrative body.

- 8 **Axon Fleet Termination.** Axon may terminate Agency's Fleet subscription for non-payment. Upon any termination:

- 8.1 Axon Fleet subscription coverage terminates, and no refunds will be given.
- 8.2 Axon will not and has no obligation to provide the Axon Fleet Upgrade.
- 8.3 Agency will be responsible for payment of any missed payments due to the termination before being allowed to purchase any future Fleet TAP.



---

## Axon Respond Appendix

This Axon Respond Appendix applies to both Axon Respond and Axon Respond Plus.

- 1 **Axon Respond Subscription Term.** If Agency purchases Axon Respond as part of a bundled offering, the Axon Respond subscription begins on the later of the (1) start date of that bundled offering, or (2) date Axon provisions Axon Respond to Agency.

If Agency purchases Axon Respond as a standalone, the Axon Respond subscription begins the later of the (1) date Axon provisions Axon Respond to Agency, or (2) first day of the month following the Effective Date.

The Axon Respond subscription term will end upon the completion of the Axon Evidence Subscription associated with Axon Respond.

- 2 **Scope of Axon Respond.** The scope of Axon Respond is to assist Agency with real-time situational awareness during critical incidents to improve officer safety, effectiveness, and awareness. In the event Agency uses Axon Respond outside this scope, Axon may initiate good-faith discussions with Agency on upgrading Agency's Axon Respond to better meet Agency's needs.

- 3 **Axon Body 3 LTE Requirements.** Axon Respond is only available and usable with an LTE enabled body-worn camera. Axon is not liable if Agency utilizes the LTE device outside of the coverage area or if the LTE carrier is unavailable. LTE coverage is only available in the United States, including any U.S. territories. Axon may utilize a carrier of Axon's choice to provide LTE service. Axon may change LTE carriers during the Term without Agency's consent.

- 4 **Axon Fleet 3 LTE Requirements.** Axon Respond is only available and usable with a Fleet 3 system configured with LTE modem and service. Agency is responsible for providing LTE service for the modem. Coverage and availability of LTE service is subject to Agency's LTE carrier.

- 5 **Axon Respond Service Limitations.** Agency acknowledges that LTE service is made available only within the operating range of the networks. Service may be temporarily refused, interrupted, or limited because of: (a) facilities limitations; (b) transmission limitations caused by atmospheric, terrain, other natural or artificial conditions adversely affecting transmission, weak batteries, system overcapacity, movement outside a service area or gaps in coverage in a service area and other causes reasonably outside of the carrier's control such as intentional or negligent acts of third parties that damage or impair the network or disrupt service; or (c) equipment modifications, upgrades, relocations, repairs, and other similar activities necessary for the proper or improved operation of service.

With regard to Axon Body 3, Partner networks are made available as-is and the carrier makes no warranties or representations as to the availability or quality of roaming service provided by carrier partners, and the carrier will not be liable in any capacity for any errors, outages, or failures of carrier partner networks. Agency expressly understands and agrees that it has no contractual relationship whatsoever with the underlying wireless service provider or its affiliates or contractors and Agency is not a third-party beneficiary of any agreement between Axon and the underlying carrier.

- 6 **Termination.** Upon termination of this Agreement, or if Agency stops paying for Axon Respond or bundles that include Axon Respond, Axon will end Aware services, including any Axon-provided LTE service.

---

**Add-on Services Appendix**

This Appendix applies to Axon Citizen for Communities, Axon Redaction Assistant, and Axon Performance.

- 1** **Subscription Term.** If Agency purchases Axon Citizen for Communities, Axon Redaction Assistant, or Axon Performance as part of OSP 7, the subscription begins on the later of the (1) start date of the OSP 7 Term, or (2) date Axon provisions Axon Citizen for Communities, Axon Redaction Assistant, or Axon Performance to Agency.

If Agency purchases Axon Citizen for Communities, Axon Redaction Assistant, or Axon Performance as a standalone, the subscription begins the later of the (1) date Axon provisions Axon Citizen for Communities, Axon Redaction Assistant, or Axon Performance to Agency, or (2) first day of the month following the Effective Date.

The subscription term will end upon the completion of the Axon Evidence Subscription associated with the add-on.

- 2** **Axon Citizen Storage.** For Axon Citizen, Agency may store an unlimited amount of data submitted through the public portal ("**Portal Content**"), within Agency's Axon Evidence instance. The post-termination provisions outlined in the Axon Cloud Services Terms of Use Appendix also apply to Portal Content.

- 3** **Performance Auto-Tagging Data.** In order to provide some features of Axon Performance to Agency, Axon will need to store call for service data from Agency's CAD or RMS.

---

**Axon Auto-Transcribe Appendix**

This Appendix applies to Axon Auto-Transcribe.

- 1) **Subscription Term.** If Agency purchases Axon Auto-Transcribe as part of a bundle or Axon Cloud Services subscription, the subscription begins on the later of the (1) start date of the bundle or Axon Cloud Services license term, or (2) date Axon provisions Axon Auto-Transcribe to Agency. If Agency purchases Axon Auto-Transcribe minutes as a standalone, the subscription begins on the date Axon provisions Axon Auto-Transcribe to Agency.

Axon Auto-Transcribe minutes expire one year after being provisioned to Agency by Axon.

If Agency cancels Auto-Transcribe services, any amounts owed by the Parties will be based on the amount of time passed under the annual subscription, rather than on the number of minutes used, regardless of usage.

- 2) **Auto-Transcribe A-La-Carte Minutes.** Upon Axon granting Agency a set number of minutes, Agency may utilize Axon Auto-Transcribe, subject to the number of minutes allowed on the Quote. Agency will not have the ability to roll over unused minutes to future Auto-Transcribe terms. Axon may charge Agency additional fees for exceeding the number of purchased minutes.
- 3) **Axon Auto-Transcribe On-Demand.** Upon Axon granting Agency an On-Demand subscription to Axon Auto-Transcribe, Agency may utilize Axon Auto-Transcribe with no limit on the number of minutes. The scope of Axon Auto-Transcribe On-Demand is to assist Agency with reviewing and transcribing individual evidence items. In the event Agency uses Axon Auto-Transcribe On-Demand outside this scope, Axon may initiate good-faith discussions with Agency on upgrading Agency's Axon Auto-Transcribe On-Demand to better meet Agency's needs.
- 4) **Warranty.** Axon does not warrant the accuracy of Axon Auto-Transcribe.

---

**Axon Virtual Reality Content Terms of Use Appendix**

- 1 **Term.** The Quote will detail the duration of the Virtual Reality Content license.
- 2 **Headsets.** Agency may purchase additional virtual reality headsets from Axon. In the event Agency decides to purchase additional virtual reality headsets for use with Axon's Virtual Reality Content, Agency must purchase those headsets from Axon.
- 3 **License Restrictions.** All licenses will immediately terminate if Agency does not comply with any term of this Agreement. If Agency utilizes more users than stated in this Agreement, Agency must purchase additional Virtual Reality Content licenses from Axon. Agency may not use Virtual Reality Content for any purpose other than as expressly permitted by this Agreement. Agency may not:
  - 3.1 modify, tamper with, repair, or otherwise create derivative works of Virtual Reality Content;
  - 3.2 reverse engineer, disassemble, or decompile Virtual Reality Content or apply any process to derive the source code of Virtual Reality Content, or allow others to do the same;
  - 3.3 copy Virtual Reality Content in whole or part, except as expressly permitted in this Agreement;
  - 3.4 use trade secret information contained in Virtual Reality Content;
  - 3.5 resell, rent, loan or sublicense Virtual Reality Content;
  - 3.6 access Virtual Reality Content to build a competitive device or service or copy any features, functions, or graphics of Virtual Reality Content; or
  - 3.7 remove, alter, or obscure any confidentiality or proprietary rights notices (including copyright and trademark notices) of Axon or Axon's licensors on or within Virtual Reality Content or any copies of Virtual Reality Content.
- 4 **Termination.** Axon may terminate Agency's license immediately for Agency's failure to comply with any of the terms in this Agreement.



---

## Flock Software Terms of Use Appendix

### 1 Definitions.

Certain capitalized terms, not otherwise defined herein, have the meanings set forth or cross-referenced in this Section 1.

“**Aggregated Data**” means information that relates to a group or category of customers, from which individual customer identities have been removed, that is not linked or reasonably linkable to any customer, including via a device.

“**Authorized End User**” shall mean any individual employees, agents, or contractors of Customer accessing or using the Flock Services through the Web Interface, under the rights granted to Customer pursuant to this Agreement.

“**Customer Data**” will mean the data, media and content provided by Customer through the Flock Services. For the avoidance of doubt, the Customer Data will include the Footage and geolocation information and environmental data collected by sensors built into the Units.

“**Documentation**” will mean text and/or graphical documentation, whether in electronic or printed format, that describe the features, functions and operation of the Flock Services which are provided by Flock to Customer in accordance with the terms of this Agreement.

“**Embedded Software**” will mean the software and/or firmware embedded or preinstalled on the Hardware.

“**Flock IP**” will mean the Flock Services, the Documentation, the Hardware, the Embedded Software, the Installation Services, and any and all intellectual property therein or otherwise provided to Customer and/or its Authorized End Users in connection with the foregoing.

“**Flock Services**” means the provision, via the Web Interface, of Flock’s software application for automatic license plate detection, searching image records, and sharing Footage.

“**Flock System**” means collectively, the Hardware, Embedded Software, and Flock Services.

“**Footage**” means still images and/or video captured by the Hardware in the course of and provided via the Flock Services.

“**Hardware**” shall mean the Flock cameras and any other physical elements that interact with the Embedded Software and the Web Interface to provide the Flock Services. The term “**Hardware**” excludes the Embedded Software.

“**Implementation Fee(s)**” means the monetary fees associated with the Installation Services, as defined in Section 1.9 below.

“**Installation Services**” means the services provided by Flock including the installation, placements and configuration of the Hardware, pursuant to any Statement of Work.

“**Non-Customer End User**” means a Flock customer that has elected to give Customer access to its data in the Flock System.

“**Non-Customer End User Data**” means the Footage, geolocation data, environmental data and/or notifications of a Non-Customer End User.

“**Support Services**” shall mean On-site Services and Monitoring Services, as defined in Section 2.9 below.

“**Unit(s)**” shall mean the Hardware together with the Embedded Software.

“**Usage Fee**” means the subscription fees to be paid by the Customer for ongoing access to Services and Hardware.

“**Web Interface**” means the website(s) or application(s) through which Customer and its Authorized End Users can access the Flock Services in accordance with the terms of this Agreement.

## 2 **Flock Services.**

**2.1 Provision of Access.** Subject to the terms of this Agreement, Flock hereby grants to Customer a non-exclusive, non-transferable right to access the features and functions of the Flock Services via the Web Interface during the term of Customer’s agreement, solely for the Authorized End Users. The Footage will be available for Customer’s designated administrator, listed on the Order Form, and any Authorized End Users to access via the Web Interface for thirty (30) days. Authorized End Users will be required to sign up for an account, and select a password and username (“**User ID**”). Flock will also provide Customer with the Documentation to be used in accessing and using the Flock Services. Customer shall be responsible for all acts and omissions of Authorized End Users, and any act or omission by an Authorized End User which, if undertaken by Customer, would constitute a breach of this Agreement, shall be deemed a breach of this Agreement by Customer. Customer shall undertake reasonable efforts to make all Authorized End Users aware of the provisions of this Agreement as applicable to such Authorized End User’s use of the Services, and shall cause Authorized End Users to comply with such provisions. Flock may use the services of one or more third parties to deliver any part of the Flock Services, including without limitation using a third party to host the Web Interface which makes the Flock Services available to Customer and Authorized End Users. Flock will pass through any warranties that Flock receives from its then-current third-party service provider to the extent that such warranties can be provided to Customer. Except in the event of Flock’s willful misconduct or negligence, such warranties as provided by such third-parties are Customer’s sole and exclusive remedy and Flock’s sole and exclusive liability with regard to such third-party services, including without limitation, hosting the web interface. Customer agrees to comply with any acceptable use policies and other terms of any third party service provider that are provided or otherwise made available to Customer from time to time.

**2.2 Embedded Software License.** Subject to all terms of this Agreement, Flock grants Customer a limited, non-exclusive, non-transferable, non-sublicensable (except to the Authorized End Users), revocable right to use the Embedded Software as installed on the Hardware by Flock; in each case, solely as necessary for Customer to use the Flock Services.

**2.3 Documentation License.** Subject to the terms of this Agreement, Flock hereby grants to Customer a non-exclusive, non-transferable right and license to use the Documentation during the Service Term for Customer’s internal purposes in connection with its use of the Flock Services as contemplated herein.

**2.4 Usage Restrictions.** The purpose for usage of the Hardware, Documentation, Services, support, and Flock IP is solely to facilitate gathering evidence that could be used in a lawful criminal investigation by the appropriate government agency and not for tracking activities that the system is not designed to capture (“**Permitted Purpose**”). Customer will not, and will not permit any Authorized End Users to, (i) copy or duplicate any of the Flock IP; (ii) decompile, disassemble, reverse engineer or otherwise attempt to obtain or perceive the source code from which any software component of any of the Flock IP is compiled or interpreted, or apply any other process or procedure to derive the source code of any software included in the Flock IP, or attempt to do any of the foregoing, and Customer

---

Title: Master Services and Purchasing Agreement between Axon and Agency (Online)

Department: Legal

Version: 1.0

Release Date: 3/31/2021

Page 25 of 47

acknowledges that nothing in this Agreement will be construed to grant Customer any right to obtain or use such source code; (iii) modify, alter, tamper with or repair any of the Flock IP, or create any derivative product from any of the foregoing, or attempt to do any of the foregoing, except with the prior written consent of Flock; (iv) interfere or attempt to interfere in any manner with the functionality or proper working of any of the Flock IP; (v) remove, obscure, or alter any notice of any intellectual property or proprietary right appearing on or contained within any of the Flock Services or Flock IP; (vi) use the Flock Services, support, Hardware, Documentation or the Flock IP for anything other than the Permitted Purpose; or (vii) assign, sublicense, sell, resell, lease, rent or otherwise transfer or convey, or pledge as security or otherwise encumber, Customer's rights under Sections 2.1, 2.2, or 2.3.

**2.5 Retained Rights; Ownership.** As between the Parties, subject to the rights granted in this Agreement, Flock and its licensors retain all right, title and interest in and to the Flock IP and its components, and Customer acknowledges that it neither owns nor acquires any additional rights in and to the foregoing not expressly granted by this Agreement. Customer further acknowledges that Flock retains the right to use the foregoing for any purpose in Flock's sole discretion. There are no implied rights.

**2.6 Suspension.** Notwithstanding anything to the contrary in this Agreement, Flock may temporarily suspend Customer's and any Authorized End User's access to any portion or all of the Flock IP if (i) Flock reasonably determines that (a) there is a threat or attack on any of the Flock IP; (b) Customer's or any Authorized End User's use of the Flock Service disrupts or poses a security risk to the Flock Service or any other customer or vendor of Flock; (c) Customer or any Authorized End User is/are using the Flock IP for fraudulent or illegal activities; (d) Flock's provision of the Flock Services to Customer or any Authorized End User is prohibited by applicable law; (e) any vendor of Flock has suspended or terminated Flock's access to or use of any third party services or products required to enable Customer to access the Flock; or (f) Customer has violated any term of this provision, including, but not limited to, utilizing the Services for anything other than the Permitted Purpose, and has failed to cure such violation within thirty days following written notice of such violation from Flock (each such suspension, in accordance with this Section 2.6, a "**Service Suspension**"). Flock will make commercially reasonable efforts, circumstances permitting, to provide written notice of any Service Suspension to Customer (including notices sent to Flock's registered email address) and to provide updates regarding resumption of access to the Flock IP following any Service Suspension. Flock will use commercially reasonable efforts to resume providing access to the Flock Service as soon as reasonably possible after the event giving rise to the Service Suspension is cured. Flock will extend the Customer's term by the duration of any suspension (for any continuous suspension lasting at least one full day) where the Service Suspension is not caused by the direct Customer's actions or by the actions of parties associated with the Customer. Flock will have no liability for any damage, liabilities, losses (including any loss of data or profits) or any other consequences that Customer or any Authorized End User may incur as a result of a Service Suspension.

**2.7 Installation Services.**

**2.7.1. Designated Locations.** Prior to performing the physical installation of the Units, Flock shall advise Customer on the location and positioning of the Units for optimal license plate image capture, as conditions and location allow. While Flock will provide advice regarding the location of positioning of such Units, Customer will have the ultimate decision regarding the location, position and angle of the Units (each Unit location so designated by Customer, a "**Designated Location**"). Due to the fact that Customer selects the Designated Location, Flock shall have no liability to Customer resulting from any poor performance, functionality or Footage resulting from or otherwise relating to the Designated Locations. After an installation plan with Designated Locations and equipment has been agreed upon by both Flock and the Customer, any subsequent changes to the installation plan

---

Title: Master Services and Purchasing Agreement between Axon and Agency (Online)

Department: Legal

Version: 1.0

Release Date: 3/31/2021

Page 26 of 47

driven by Customer's request will incur a \$250 charge in addition to any equipment charges. These changes include but are not limited to camera re-positioning, adjusting of camera mounting, re-angling, changes to heights of poles, and removing foliage.

- 2.7.2. Customer's Installation Obligations.** Customer agrees to allow Flock and its agents reasonable access to the designated installation locations at all reasonable times upon reasonable notice for the purpose of performing the installation work (together with the preceding sentence, the "**Customer Installation Obligations**"). It is understood that the Implementation Fees do not include any permits or associated costs, any federal, state or local taxes including property, license, privilege, sales, use, excise, gross receipts or other similar taxes which may now or hereafter become applicable to, measured by or imposed upon or with respect to the installation of the Hardware, its use, or any other services performed in connection therewith and that Customer shall be solely responsible for the foregoing. Customer represents and warrants that it has all necessary right title and authority and hereby authorizes Flock to install the Hardware at the Designated Locations and to make any necessary inspections or tests in connection with such installation.
- 2.7.3. Flock's Installation Obligations.** The Hardware shall be installed in a workmanlike manner in accordance with Flock's standard installation procedures, and the installation will be completed within a reasonable time from the time that the Designated Locations are selected by Customer. Following the initial installation of the Hardware and any subsequent Reinstalls or maintenance operations, Flock's obligation to perform installation work shall cease; however, Flock will continue to monitor the performance of the Units for the length of the Term and will receive access to the Footage for a period of three (3) business days after the initial installation in order to monitor performance and provide any necessary maintenance solely as a measure of quality control. Customer can opt out of Flock's access to Footage after the initial installation which would waive Flock's responsibility to ensure such action was successful. Customer understands and agrees that the Flock Services will not function without the Hardware. Labor may be provided by Flock or a third party.
- 2.7.4. Theft and Damage.** Flock agrees to replace the Hardware up to one (1) time during the Term of the Agreement, at no cost to Customer, in the event of theft or damage. Subsequent replacement due to damage or theft will be at Customer's own expense, at a replacement cost of three hundred dollars (\$300) per camera. Customer shall not be required to replace subsequently damaged or stolen units; however, Customer understands and agrees that functionality, including Footage, will be materially affected due to such subsequently damaged or stolen units and that Flock will have no liability to Customer regarding such affected functionality nor shall the Fees owed be impacted.
- 2.7.5. Security Interest.** The Hardware shall remain the personal property of Flock and will be removed upon the termination or expiration of Customer's Agreement. Customer agrees to perform all acts which may be necessary to assure the retention of title of the Hardware by Flock. Should Customer default in any payment for the Flock Services or any part thereof or offer to sell or auction the Hardware, then Customer authorizes and empowers Flock to remove the Hardware or any part thereof. Such removal, if made by Flock, shall not be deemed a waiver of Flock's rights to any damages Flock may sustain as a result of Customer's default and Flock shall have the right to enforce any other legal remedy or right.

- 2.8 Hazardous Conditions.** Unless otherwise stated in the Agreement, Flock's price for its services under this Agreement does not contemplate work in any areas that contain hazardous materials, or other hazardous conditions, including, without limit, asbestos, lead, toxic or flammable substances. In the event any such hazardous materials are discovered in the designated locations in which Flock is to perform services under this

---

Title: Master Services and Purchasing Agreement between Axon and Agency (Online)

Department: Legal

Version: 1.0

Release Date: 3/31/2021

Page 27 of 47

Agreement, Flock shall have the right to cease work immediately in the area affected until such materials are removed or rendered harmless. Any additional expenses incurred by Flock as a result of the discovery or presence of hazardous material or hazardous conditions shall be the responsibility of Customer and shall be paid promptly upon billing.

**2.9 Support Services.** Subject to the payment of fees, Flock shall monitor the performance and of Flock Services and may, from time to time, advise Customer on changes to the Services or the Designated Locations which may improve the performance or functionality of the Services or may improve the quality of the Footage. The work, its timing, and the fees payable relating to such work shall be agreed by the Parties prior to any alterations to or changes of the Services or the Designated Locations (“**Monitoring Services**”). Subject to the terms hereof, Flock will provide Customer with reasonable technical and on-site support and maintenance services (“**On-Site Services**”) in-person or by email at hello@flocksafety.com. Flock will use commercially reasonable efforts to respond to requests for support.

**2.10 Intentionally deleted.**

**2.11 Changes to Platform.** Flock Safety may, in its sole discretion, make any changes to any system or platform that it deems necessary or useful to (i) maintain or enhance (a) the quality or delivery of Flock Safety’s products or services to its customers, (b) the competitive strength of, or market for, Flock Safety’s products or services, (c) such platform or system’s cost efficiency or performance, or (ii) to comply with applicable law.

**3 Customer Responsibilities.**

**3.1 Customer Obligations.** Upon creation of a User ID, Customer agrees to provide Flock with accurate, complete, and updated registration information. Customer may not select as its User ID a name that Customer does not have the right to use, or another person’s name with the intent to impersonate that person. Customer may not transfer its account to anyone else without prior written permission. Customer will not share its account or password with anyone and must protect the security of its account and password. Customer is responsible for any activity associated with its account. Customer shall be responsible for obtaining and maintaining any equipment and ancillary services needed to connect to, access or otherwise use the Services. Customer will, at its own expense, provide assistance to Flock, including, but not limited to, by means of access to, and use of, Customer facilities, as well as by means of assistance from Customer personnel to the limited extent any of the foregoing may be reasonably necessary to enable Flock to perform its obligations hereunder, including, without limitation, any obligations with respect to Support Services or any Installation Services.

**3.2 Customer Representations and Warranties.** Customer represents, covenants, and warrants that Customer will use the Services only in compliance with this Agreement and all applicable laws and regulations, including but not limited to any laws relating to the recording or sharing of video, photo, or audio content. To the extent allowed by the governing law of the state mentioned in Section 9.6, or if no state is mentioned in Section 9.6, by the law of the State of Georgia, Customer hereby agrees to indemnify and hold harmless Flock against any damages, losses, liabilities, settlements and expenses, including without limitation costs and attorneys’ fees, in connection with any claim or action that arises from an alleged violation of Customer’s representations and warranties made pursuant to this Section 3.2, Customer’s Installation Obligations, or otherwise from Customer’s use of the Flock Services, Hardware and any Embedded Software, including any claim that such actions violate any applicable law or third party right. Although Flock has no obligation to monitor Customer’s use of the Flock Services, Flock may do so and may prohibit any use of the Services it believes may be (or alleged to be) in violation of the foregoing.



- 4 Confidentiality; Data, Feedback; Aggregated Statistics.**
- 4.1 Customer and Non-Customer End User Data.** As between Flock and Customer, all right, title and interest in the Customer Data and Non-Customer End User Data, belong to and are retained solely by Customer. Customer hereby grants to Flock a limited, non-exclusive, royalty-free, worldwide license to use the Customer Data and Non-Customer End User Data and perform all acts with respect to the Customer Data and Non-Customer End User Data as may be necessary for Flock to provide the Flock Services to Customer, and a non-exclusive, perpetual, irrevocable, worldwide, royalty-free, fully paid license to use, reproduce, modify and distribute the Customer Data and Non-Customer End User Data as a part of the Aggregated Data (as defined in Section 4.4 below). This Agreement does not by itself make any Non-Customer End User Data the sole property or the Proprietary Information of Customer.
- 4.2 Feedback.** If Customer provides any suggestions, ideas, enhancement requests, feedback, recommendations or other information relating to the subject matter hereunder, Customer hereby assigns (and will cause its agents and representatives to assign) to Flock all right, title and interest (including intellectual property rights) with respect to or resulting from any of the foregoing.
- 4.3 Aggregated Data.** Notwithstanding anything in this Agreement to the contrary, Flock shall have the right to collect and analyze data and other information relating to the provision, use and performance of various aspects of the Flock Services and related systems and technologies (including, without limitation, information concerning Customer Data and data derived therefrom). For the sake of clarity, Aggregated Data is compiled anonymous data which has been stripped of any personal identifying information. Customer acknowledges that Flock will be compiling Aggregated Data based on Customer Data and Non-Customer End User Data input into the Flock Services (“**Aggregated Data**”). Customer hereby grants Flock a non-exclusive, worldwide, perpetual, royalty-free right and license (during and after the Service Term hereof) to use and distribute such Aggregated Data to improve and enhance the Services and for other marketing, development, diagnostic and corrective purposes in connection with the Flock Services and other Flock offerings. No rights or licenses are granted except as expressly set forth herein.
- 4.4 Confidentiality.** Each Party (the “**Receiving Party**”) understands that the other Party (the “**Disclosing Party**”) has disclosed or may disclose business, technical or financial information relating to the Disclosing Party’s business (hereinafter referred to as “**Proprietary Information**” of the Disclosing Party). Proprietary Information of Flock includes non-public information regarding features, functionality and performance of the Services. Proprietary Information of Customer includes non-public data provided by Customer to Flock or collected by Flock via the Unit, including the Footage, to enable the provision of the Services, which includes but is not limited to geolocation information and environmental data collected by sensors built into the Units (“**Customer Data**”). The Receiving Party agrees: (i) to take the same security precautions to protect against disclosure or unauthorized use of such Proprietary Information that the party takes with its own proprietary information, but in no event will the Receiving Party apply less than reasonable precautions to protect such Proprietary Information, and (ii) not to use (except in performance of the Services or as otherwise permitted herein) or divulge to any third person any such Proprietary Information. Flock’s use of the Proprietary Information may include processing the Proprietary Information to send Customer alerts, such as when a car exits Customer’s neighborhood, or to analyze the data collected to identify motion or other events. The Disclosing Party agrees that the foregoing shall not apply with respect to any information that the Receiving Party can document (a) is or becomes generally available to the public, or (b) was in its possession or known by it prior to receipt from the Disclosing Party, or (c) was rightfully disclosed to it without restriction by a third party, or (d) was independently developed without use of any Proprietary Information of the Disclosing Party. Nothing in this Agreement will prevent the Receiving Party from

---

Title: Master Services and Purchasing Agreement between Axon and Agency (Online)

Department: Legal

Version: 1.0

Release Date: 3/31/2021

Page 29 of 47



disclosing the Proprietary Information pursuant to any judicial or governmental order, provided that the Receiving Party gives the Disclosing Party reasonable prior notice of such disclosure to contest such order. For clarity, Flock may access, use, preserve and/or disclose the Footage to law enforcement authorities, government officials, and/or third parties, if legally required to do so or if Flock has a good faith belief that such access, use, preservation or disclosure is reasonably necessary to: (a) comply with a legal process or request; (b) enforce this Agreement, including investigation of any potential violation thereof; (c) detect, prevent or otherwise address security, fraud or technical issues; or (d) protect the rights, property or safety of Flock, its users, a third party, or the public as required or permitted by law, including respond to an emergency situation. In the event Customer requests Flock to enable law enforcement monitoring against law enforcement hotlists, Customer hereby expressly grants Flock a non-exclusive, worldwide, perpetual, royalty-free right and license (during and after the term hereof) to disclose the Customer Data (inclusive of any Footage and Footage search access) to enable law enforcement monitoring against law enforcement hotlists. Flock may store deleted Footage in order to comply with certain legal obligations but such retained Footage will not be retrievable without a valid court order, subject to Section 9.1 below.

5 **RESERVED.**

6 **RESERVED.**

7 **Remedy; Warranty; and Disclaimer.**

7.1 **Remedy.** Upon a malfunction or failure of Hardware or Embedded Software (a “Defect”), Customer must first make commercially reasonable efforts to address the problem by contacting Flock’s technical support as described in Section 2.9 above. If such efforts do not correct the Defect, Flock shall, or shall instruct one of its contractors to, in its sole discretion, repair or replace the Hardware or Embedded Software suffering from the Defect. Flock reserves the right in their sole discretion to refuse or delay replacement or its choice of remedy for a Defect until after it has inspected and tested the affected Unit; provided that such inspection and test shall occur within seventy-two (72) hours after Customer notifies the Flock of a Defect. In the event of a Defect, Flock will repair or replace the defective Unit at no additional cost. In the event that a Unit is lost, stolen, or damaged, Flock agrees to replace the Unit at a fee according to the then-current Reinstall Policy (<https://www.flocksafety.com/reinstall-fee-schedule>). Customer shall not be required to replace subsequently lost, damaged or stolen Units, however, Customer understands and agrees that functionality, including Footage, will be materially affected due to such subsequently lost, damaged or stolen units and that Flock will have no liability to Customer regarding such affected functionality nor shall the Usage Fee or Implementation Fees owed be impacted.

7.2 **Exclusions.** Flock will not provide the remedy described in Section 7.1 above if any of the following exclusions apply: (a) misuse of the Hardware or Embedded Software in any manner, including operation of the Hardware or Embedded Software in any way that does not strictly comply with any applicable specifications, documentation, or other restrictions on use provided by Flock; (b) damage, alteration, or modification of the Hardware or Embedded Software in any way; or (c) combination of the Hardware or Embedded Software with software, hardware or other technology that was not expressly authorized by Flock.

7.3 **Warranty.** Flock shall use reasonable efforts consistent with prevailing industry standards to maintain the Services in a manner which minimizes errors and interruptions in the Flock Services. Flock Services may be temporarily unavailable for scheduled maintenance or for unscheduled emergency maintenance, either by Flock or by third-party providers, or because of other causes beyond Flock’s reasonable control, but Flock shall use reasonable efforts to provide advance notice in writing or by e-mail of any scheduled service disruption.

**7.4 Disclaimer.** THE REMEDY DESCRIBED IN SECTION 7.1 ABOVE IS CUSTOMER'S SOLE REMEDY, AND FLOCK'S SOLE LIABILITY, WITH RESPECT TO DEFECTIVE HARDWARE AND/OR EMBEDDED SOFTWARE. THE FLOCK DOES NOT WARRANT THAT THE FLOCK SERVICES WILL BE UNINTERRUPTED OR ERROR FREE; NOR DOES IT MAKE ANY WARRANTY AS TO THE RESULTS THAT MAY BE OBTAINED FROM USE OF THE FLOCK SERVICES. EXCEPT AS EXPRESSLY SET FORTH IN THIS SECTION, THE FLOCK SERVICES AND INSTALLATION SERVICES ARE PROVIDED "AS IS" AND FLOCK DISCLAIMS ALL WARRANTIES, EXPRESS OR IMPLIED, INCLUDING, BUT NOT LIMITED TO, IMPLIED WARRANTIES OF MERCHANTABILITY AND FITNESS FOR A PARTICULAR PURPOSE AND NON-INFRINGEMENT.

**7.5 Force Majeure.** Flock Safety is not responsible nor liable for any delays or failures in performance from any cause beyond its control, including, but not limited to acts of God, changes to law or regulations, embargoes, war, terrorist acts, riots, fires, earthquakes, floods, power blackouts, strikes, weather conditions or acts of hackers, internet service providers or any other third party or acts or omissions of Customer or any Authorized End User.

**8 Limitation of Liability and Indemnity.**

**8.1 Limitation of Liability.** NOTWITHSTANDING ANYTHING TO THE CONTRARY, FLOCK AND ITS SUPPLIERS (INCLUDING BUT NOT LIMITED TO ALL HARDWARE AND TECHNOLOGY SUPPLIERS), OFFICERS, AFFILIATES, REPRESENTATIVES, CONTRACTORS AND EMPLOYEES SHALL NOT BE RESPONSIBLE OR LIABLE WITH RESPECT TO ANY SUBJECT MATTER OF THIS AGREEMENT OR TERMS AND CONDITIONS RELATED THERETO UNDER ANY CONTRACT, NEGLIGENCE, STRICT LIABILITY, PRODUCT LIABILITY, OR OTHER THEORY: (A) FOR ERROR OR INTERRUPTION OF USE OR FOR LOSS OR INACCURACY, INCOMPLETENESS OR CORRUPTION OF DATA OR FOOTAGE OR COST OF PROCUREMENT OF SUBSTITUTE GOODS, SERVICES OR TECHNOLOGY OR LOSS OF BUSINESS; (B) FOR ANY INDIRECT, EXEMPLARY, INCIDENTAL, SPECIAL OR CONSEQUENTIAL DAMAGES; (C) FOR ANY MATTER BEYOND FLOCK'S ACTUAL KNOWLEDGE OR REASONABLE CONTROL INCLUDING REPEAT CRIMINAL ACTIVITY OR INABILITY TO CAPTURE FOOTAGE OR IDENTIFY AND/OR CORRELATE A LICENSE PLATE WITH THE FBI DATABASE; (D) FOR ANY PUBLIC DISCLOSURE OF PROPRIETARY INFORMATION MADE IN GOOD FAITH; OR (E) FOR ANY AMOUNTS THAT, TOGETHER WITH AMOUNTS ASSOCIATED WITH ALL OTHER CLAIMS, EXCEED THE FEES PAID AND/OR PAYABLE BY CUSTOMER TO FLOCK FOR THE FLOCK SERVICES UNDER THIS AGREEMENT IN THE TWELVE (12) MONTHS PRIOR TO THE ACT THAT GAVE RISE TO THE LIABILITY, IN EACH CASE, WHETHER OR NOT FLOCK HAS BEEN ADVISED OF THE POSSIBILITY OF SUCH DAMAGES. IN THE EVENT OF AN EMERGENCY, CUSTOMER SHOULD CONTACT 911 AND SHOULD NOT RELY ON THE FLOCK SERVICES.

**8.2 Responsibility.** Each Party to this Agreement shall assume the responsibility and liability for the acts and omissions of its own employees, deputies, officers, or agents, in connection with the performance of their official duties under this Agreement. Each Party to this Agreement shall be liable (if at all) only for the torts of its own officers, agents, or employees that occur within the scope of their official duties. Customer will not pursue any claims or actions against Flock's suppliers.

**8.3 Indemnity.** Customer hereby agrees to indemnify and hold harmless Flock against any damages, losses, liabilities, settlements and expenses (including without limitation costs and attorneys' fees) in connection with any claim or action that arises from an alleged violation of Section 3.1, a breach of this Agreement, Customer's sharing of any data in connection with the Flock system, Flock employees or agent or Non-Customer End Users,

---

Title: Master Services and Purchasing Agreement between Axon and Agency (Online)

Department: Legal

Version: 1.0

Release Date: 3/31/2021

Page 31 of 47

or otherwise from Customer's use of the Flock Services, Hardware and any Software, including any claim that such actions violate any applicable law or third party right. Although Flock has no obligation to monitor Customer's use of the Flock Services, Flock may do so and may prohibit any use of the Flock Services it believes may be (or alleged to be) in violation of the Section 3.2 or this Agreement.

**9 Record Retention.**

**9.1 Data Preservation.** The Customer agrees to store Customer Data and Non-Customer End User Data in compliance with all applicable local, state and federal laws, regulations, policies and ordinances and their associated record retention schedules. As part of Customer's consideration for paid access and no-fee access to the Flock System, to the extent that Flock is required by local, state or federal law to store the Customer Data or the Non-Customer End User Data, Customer agrees to preserve and securely store this data on Flock's behalf so that Flock can delete the data from its servers and, should Flock be legally compelled by judicial or government order, Flock may retrieve the data from Customer upon demand, provided, however, if Flock receives a disclosure request for Customer Data, Flock will give Customer notice, unless legally prohibited from doing so, to allow Customer to file an objection with the court or administrative body.

**10 Miscellaneous.**

**10.1 Publicity.** Flock has the right to reference and use Customer's name and trademarks and disclose the nature of the Flock Services provided hereunder in each case in business and development and marketing efforts, including without limitation on Flock's website.

**10.2 Export.** Customer may not remove or export from the United States or allow the export or re-export of the Flock IP or anything related thereto, or any direct product thereof in violation of any restrictions, laws or regulations of the United States Department of Commerce, the United States Department of Treasury Office of Foreign Assets Control, or any other United States or foreign Customer or authority. As defined in FAR section 2.101, the Flock Services, the Hardware, the Embedded Software and Documentation are "commercial items" and according to DFAR section 252.2277014(a)(1) and (5) are deemed to be "commercial computer software" and "commercial computer software documentation." Consistent with DFAR section 227.7202 and FAR section 12.212, any use, modification, reproduction, release, performance, display, or disclosure of such commercial software or commercial software documentation by the U.S. Government will be governed solely by the terms of this Agreement and will be prohibited except to the extent expressly permitted by the terms of this Agreement.

## Skydio Terms of Use Appendix

### 1 Definitions.

**“Advanced Software”** means optional capabilities, functions or other features of the Onboard Software that may be specified and identified as such in the Quote. Skydio’s characterization of capabilities, functions or other features as Advanced Software shall be dispositive. Notwithstanding any other provision herein, a software feature that is locked or otherwise disabled unless or until an Advanced Software Package is purchased for such software feature shall be deemed an Advanced Software. Advanced Software does not include Mobile Apps.

**“Advanced Software Package”** means an optional, additional-charge license right, specified in the Quote, pursuant to which Skydio shall unlock Advanced Software to permit Customer to use Advanced Software (and in some cases the Skydio Hardware that it controls).

**“Authorized Devices”** are (a) mobile devices that Customer owns or is authorized to use, and (b) controllers purchased by Customer hereunder, which in each case (a) and (b) are used by Customer to operate the Skydio Hardware purchased by Customer hereunder.

**“Base Software”** means capabilities, functions or other features of the Onboard Software that are both: (a) standard capabilities, functions or other features available and activated on Skydio’s base consumer version of Skydio Hardware, and (b) available for use without purchase of Advanced Software Package. Base Software may be specified and identified as standard features in the Quote. Any capability, function, or feature that is not a Base Software shall be deemed an Advanced Software.

**“Customer”** means the customer procuring Skydio Products or services.

**“Error”** means a critical error in the Advanced Software that causes the Advanced Software to be inoperable.

**“Skydio License Term”** means with respect to an Advanced Software Package, the term of that Advanced Software Package, including (if applicable) the initial specified term and any renewal terms.

**“Mobile Apps”** means software applications (in executable form only), as may be specified on the Quote, that are specifically intended for use on a mobile device (and any Updates thereto).

**“Onboard Software”** means software, in executable format only, embedded into or otherwise pre-installed on Skydio Hardware as supplied by Skydio, and any Updates thereto, whether or not embedded on read only memory. Onboard Software includes Base Software and Advanced Software.

**“Skydio Privacy Policy”** means Skydio’s privacy policy located at <https://www.skydio.com/privacy-policy> and as it may be amended from time to time by Skydio in its sole discretion.

**“Product”** means Skydio Hardware and Software, as provided by Skydio pursuant to this Agreement and any applicable Quote.

**“Skydio Hardware”** means drones and other unmanned aircraft, controllers, docks, accessories and related hardware that Customer purchases from Skydio or its distributors or resellers.

**“Skydio Software”** means Onboard Software and Mobile Apps.

**“Support Term”** means, for Base Software, the support term specified in the Quote, and, for each Advanced Software Package, the applicable Skydio License Term for such Advanced Software

Package purchased hereunder.

“**Updates**” means any upgrades, updates, maintenance releases, bug fixes or modified versions of Skydio Software that Skydio may release from time to time.

**2** **License.** Subject to and in accordance with the terms and conditions of this Agreement and further conditioned upon Customer’s payment of all Fees, Skydio grants to Customer:

**2.1** a limited, perpetual, non-exclusive, non-transferable (except as provided in Section 5 below titled “Transferability”) right and license to use the Base Software solely on Skydio Hardware;

**2.2** a limited, perpetual, non-exclusive, non-transferable right and license to download, install, execute and use Mobile Apps on Authorized Devices solely to operate Skydio Hardware in accordance with this Agreement;

**2.3** if Customer purchases an Advanced Software Package for the use of an Advanced Software, as specified in the Quote, a limited, non-exclusive, non-transferable right and license, during the Skydio License Term of the Advanced Software Package, to use the Advanced Software on Skydio Hardware that Customer purchases from Skydio solely to operate the Skydio Hardware in accordance with this Agreement (“**Advanced Software License**”); and

**2.4** a limited, non-exclusive, non-transferable right and license to install solely on Skydio Hardware any Updates to the Onboard Software, if and when provided by Skydio.

**3** **Additional License Terms.** Additional License Terms. The license rights of Section 2 are limited to the United States, Canada and Japan.

**3.1** Unless otherwise specified in the applicable Quote, the Advanced Software License is granted on a per-unit basis and it may only be exercised with respect to the specific units of Skydio Hardware identified on the applicable Quote or, if the Quote does not specify such units, then with respect to no more than the total number of Skydio Hardware units authorized on the Quote, or if such total number of units is not specified on the Quote, then only with respect to one (1) single Skydio Hardware unit (“**Authorized Units**”).

**3.2** Rights under the Advanced Software License are not transferable between Authorized Units. When an Advanced Software License is exercised on a specific Authorized Unit (by unlocking, activating, accessing or using the Advanced Software on that Authorized Unit), such Advanced Software License, or any rights thereof, cannot be transferred to a different unit of Skydio Hardware, except: (i) if Skydio replaces an Authorized Unit pursuant to a warranty claim, Skydio shall transfer to the replacement Authorized Unit, the Advanced Software License of the inoperable unit that is being replaced, and (ii) if a particular Authorized Unit is rendered permanently inoperable, Skydio shall, upon Customer’s request, transfer the Advanced Software License rights to a replacement Authorized Unit, provided, however, that Skydio may condition such transfer on Customer returning to Skydio the remnants of the inoperable unit or other evidence of its inoperability.

**4** **Limitations and Restrictions.** Except as otherwise expressly provided in this Agreement, the foregoing license grant excludes any right to, and Customer shall not (and shall not permit others to) do any of the following with respect to the Skydio Software: (i) license, sublicense, sell, resell, rent, lease, transfer, distribute, time share, operate as a service bureau, or otherwise make any of it available for access by third parties; (ii) disassemble, reverse engineer or decompile it; (iii) copy, create derivative works based on or otherwise modify it; (iv) remove or modify a copyright, trademark, logo or other proprietary rights notice or brand labeling in it; (v) use it to reproduce, distribute, display, transmit, or use material protected by copyright or other intellectual property right (including the rights of publicity or privacy) without first obtaining the permission of the owner; (vi) use it to create, use, send, store or run viruses or other harmful computer code, files, scripts, agents or other programs or otherwise engage, in a malicious act or disrupt its security, integrity or operation; (vii) install, execute or otherwise reproduce Onboard Software on any device other than the Skydio Hardware on which Skydio originally installed the Onboard Software; (viii) install any Skydio Software on any type of device not approved by Skydio; (ix) disable or otherwise circumvent

Title: Master Services and Purchasing Agreement between Axon and Agency (Online)



any technological measures in Skydio Software to limit its installation, use or access; (x) unlock, activate, access or use an Advanced Software on any device other than as permitted under an Advanced Software Package purchased by Customer; and (xi) publish or release any benchmarking or performance data applicable to the Skydio Software.

- 5 **Transferability.** Subject to the terms and conditions of this Agreement, Customer may transfer the Base Software, including any relevant Base Software license rights, only on a permanent basis and as part of the sale or transfer of the Skydio Hardware on which the Base Software is loaded, provided that Customer retains no copies of any version of the Skydio Software. With the exception of the Base Software, Customer may not transfer any other Skydio Software or other Skydio Software license rights granted herein to another person or entity without the express written permission of Skydio, unless allowed by applicable law stating that transfer may not be restricted.
- 6 **Evaluation License.** Skydio may make certain Skydio Software available in object code form to end users only for evaluation, training or other limited non-commercial purposes without charging a Fee (“**Evaluation License**”). Where Skydio has provided an Evaluation License, all of the terms of this Agreement shall apply except that (i) Customer’s license rights shall be limited to the evaluation of that Skydio Software, (ii) Customer shall not be required to pay a Fee for the evaluation of that Skydio Software and (iii) Skydio shall have the right to revoke the license to the Skydio Software at any time and for any reason.
- 7 **Updates.** The terms and conditions of this Agreement shall apply to all Updates or additional copies of the Skydio Software. Subject to the terms and conditions of this Agreement, including Customer’s timely payment of all Fees due and owed to Skydio, Skydio will provide or make available to Customer, during the Support Term, Updates for Base Software, Mobile Apps and any Advanced Software that was enabled under the purchased Advanced Software Package on the Authorized Units. Notwithstanding any other provision of this Agreement, Customer has no license or right to use any Updates to the Advanced Software unless Customer holds a valid license to the Advanced Software and has paid any required Fees for such Advanced Software. Updates are solely provided on a “when-and-if-available” basis and as made generally available by Skydio to its customers. Customer shall promptly install any Updates that Skydio designates as required for the continued safe operation of Skydio Hardware or operation of any Advanced Software.
- 8 **Proprietary Notices.** Customer agrees to maintain and reproduce all copyright and other proprietary notices on all copies, in any form, of the Skydio Software in the same form and manner that such copyright and other proprietary notices are included on the Skydio Software.
- 9 **Intellectual Property.** Customer agrees that all worldwide patent, copyright and other intellectual property rights in the Product, and all copies of the Software however made (including copies pre-installed on the Skydio Hardware purchased by Customer) are the exclusive property of Skydio and its suppliers. All Skydio Software is licensed to Customer, not sold. All rights not expressly granted to Customer in this Agreement are reserved by Skydio and its suppliers. There are no implied licenses under this Agreement.
- 10 **Fees.** Skydio reserves the right to suspend and/or terminate access to the Skydio Software if any undisputed fees for Skydio Hardware or Software are past due. Such suspension or termination shall not relieve Customer from its obligation to pay all undisputed amounts.
- 11 **Third Party Software and Open Source Software.** The Skydio Software may include third party software, and open source software (“**OSS**”), and such software is provided under separate license terms.
  - 11.1 To the extent the licenses for any OSS requires Skydio to make available to Customer the corresponding source code included in the Skydio Software, Customer may obtain a copy of the applicable OSS source code by sending a written request to [legal@skydio.com](mailto:legal@skydio.com). The OSS license terms shall take precedence over this Agreement to the extent that this Agreement imposes greater restrictions on Customer than the applicable OSS license

---

Title: Master Services and Purchasing Agreement between Axon and Agency (Online)

Department: Legal

Version: 1.0

Release Date: 3/31/2021

Page 35 of 47



terms. Customer acknowledges receipt of notices for the Open Source Components for the initial delivery of the Skydio Software.

- 11.2** The use of third party software or applications, or the integration of such software or applications with the Skydio Software, (collectively, “**Third Party Applications**”), may result in Customer data or information being transferred to a third party. Skydio is not responsible for, and Customer agrees to hold Skydio harmless, for any data or information transferred to third parties in connection with your use of Third Party Applications.
- 12** **Commercial Item.** The Skydio Software and associated documentation are “commercial items” as defined at FAR 2.101 and according to DFAR section 252.2277014(a)(1) and (5) are deemed to be “commercial computer software” and “commercial computer software documentation.” Consistent with DFAR section 227.7202 and FAR section 12.212, any use, modification, reproduction, release, performance, display, or disclosure of such commercial software or commercial software documentation by the U.S. Government will be governed solely by the terms of this Agreement and will be prohibited except to the extent expressly permitted by the terms of this Agreement.
- 13** **Term and Termination.** This Agreement is effective upon Skydio Software purchase, activation or download, as applicable, and shall continue until terminated.
- 13.1** **Paid License Term.** Each Advanced Software Package purchased hereunder shall have its own Skydio License Term. Each Skydio License Term shall have an initial term for the time period set forth on the Quote and that the Skydio License Term shall automatically extend for successive additional one (1) year renewal terms thereafter if any (subject to payment of the then-current applicable license fees for each such renewal term) unless either party give notice to the other of its intention not to renew the Skydio License Term at least thirty (30) days before expiration of the then-current initial or renewal term, as the case may be (“**Renewal Terms**”). If a Skydio License Term is not set forth in the Quote, each Skydio License Term shall have an initial term that commences upon the date of provisioning of the Skydio Software and expires one (1) year later; provided, however, that the Skydio License Term shall automatically extend per the Renewal Terms. Unless Skydio terminates this Agreement for breach by Customer, the perpetual licenses to use Base Software shall survive.
- 13.2** **Free or Trial License Term.** If you have obtained a license to a free version of the Skydio Software, then your license will continue until terminated in accordance with this Agreement. If you have obtained a trial license to the Skydio Software, then your license will continue for such time period as may be specified by Skydio with respect to such trial (and if no period is specified, for 30 days). Skydio may terminate a trial license at any time in its sole discretion.
- 13.3** **Termination.** Skydio may terminate Customer’s license rights under this Agreement immediately without notice if Customer fails to comply with any terms of this Agreement or Customer fails to make any payment as required hereunder. In no event will termination relieve Customer of its obligation to pay any fees payable for Skydio Hardware or Software. Upon termination or expiration of this Agreement for any reason, Customer shall immediately cease using any Skydio Software and must destroy or return to Skydio all copies of the Skydio Software and associated documentation in its possession or control. The following sections shall survive the termination or expiration of this Agreement: Sections 1, 2(a), 2(b), 2(d), 4, 5 and 7-26.
- 14** **End of Life.** Skydio may discontinue the provision of any Skydio Software, support or Updates in its sole discretion in accordance with, and any licenses granted herein are subject to, Skydio Product End of Life Policy, which is available at <https://support.skydio.com/hc/en-us/articles/360057153714>, and is hereby incorporated by reference herein.

- 15 **Limited Warranty.** The only warranty that Skydio provides with respect to any Skydio products or services is the written limited warranty statement provided with the products or services or as otherwise set forth at <https://skydio.com/warranty-terms> (“**Limited Warranty**”).
- 16 **Limitations.** Any use of the Skydio Hardware and Software, including any reliance upon or use of any of the information generated thereby, shall be at Customer’s and its authorized users’ sole risk. Except as expressly set forth in the Limited Warranty and to the extent permitted by law, the Products are provided “as is” and “as available” without warranty of any kind (all of which are hereby disclaimed), whether express, implied or statutory, including the implied warranties of merchantability, fitness for a particular purpose, or non-infringement. If statutory or implied warranties cannot be lawfully disclaimed, then such warranties are limited to the duration of the warranty set forth in the Limited Warranty and by the provisions in this Agreement. Skydio’s cumulative liability to any Party for any loss or damage resulting from any claim, demand, or action arising out of or relating to any Skydio Products or any service will not exceed the amounts paid by Customer in the 12 months prior to the action giving rise to the liability. Neither Party will be liable for direct, special, indirect, incidental, punitive or consequential damages, however caused, whether for breach of warranty or contract, negligence, strict liability, tort or any other legal theory.
- 17 **Safety and Compliance.** Customer and Customer’s authorized users agree to use the Skydio Hardware only in a manner that complies with all laws. Customer shall ensure that it and its authorized users operate product in accordance with the information and warnings set forth at <https://www.skydio.com/safety> (the “**Safety and Operating Guide**”). Customer acknowledges that improper operation of the unmanned aircraft systems may cause injury to persons or property. Customer shall at all times comply with all applicable local, state, national, and international laws and regulations related to the operation of unmanned aircraft systems in any territory of operation, including any applicable laws and orders with regard to privacy, pilot licensure, operating within visual line of sight (unless the Customer has received proper approval from a civil aviation authority waiving such limitation), detecting and avoiding other aircraft, and airspace restrictions (such as temporary flight restrictions issued by Federal Aviation Administration or other appropriate government agencies). Customer shall obtain and maintain all necessary licenses, consent, and authorizations of any kind necessary to operate unmanned aircraft systems.
- 18 **Feedback.** If Customer or Customer’s authorized users send Skydio comments, suggestions, ideas, materials, notes, drawings, concepts or other information (collectively, “**Submissions**”), Customer and Customer’s authorized users (as applicable) grant to Skydio a worldwide, non-exclusive, perpetual, irrevocable, transferable, sub-licensable, royalty-free license to use, copy, modify, publicly display, publicly perform, distribute and otherwise exploit the Submissions. None of the Submissions shall be subject to any obligation of confidentiality on Skydio’s part, and Skydio shall not be liable for any use or disclosure of any Submissions.
- 19 **Privacy.** Skydio shall, in providing the Products, comply with Skydio Privacy Policy to the extent that Customer provides Skydio with personally identifiable information.
- 20 **Mapbox Terms.** The Mobile App uses features and content provided by Mapbox, such as maps and locations on a map. Use of any such Mapbox features and content is subject to the then-current version of Mapbox’s terms and privacy policy, which can be found at <https://www.mapbox.com/legal/tos/>, including the Mapbox Government Terms of Service, which can be found at <https://www.mapbox.com/legal/usg-tos>, and you hereby agree to comply with such terms. You can opt out of location telemetry reporting pursuant to such terms.
- 21 **Services.** In accordance with this Agreement, so long as Customer timely pays all amounts owed hereunder, Skydio shall render to Customer, during the applicable Skydio License Term of each Advanced Software Package purchased herunder, the support services consisting of: (a) providing Customer’s named Administrators (defined below) with consultation in English, via telephone and email, during Skydio’s normal business hours (9AM to 5PM PST) to assist in using the Advanced Software licensed under the Advanced Software Package; and (b) making reasonable efforts to

---

Title: Master Services and Purchasing Agreement between Axon and Agency (Online)

Department: Legal

Version: 1.0

Release Date: 3/31/2021

Page 37 of 47

correct any critical error in the Advanced Software that causes the Advanced Software to be inoperable (“**Error**”), all in accordance with Skydio’s support policies published on its Website, as updated from time to time. Errors do not include, and Skydio has no obligation to correct, malfunctions caused in whole or in part by modification of Software, the operation of third-party products or the integration of Software with or into third-party products, improper installation of the Advanced Software or other Software, or the use of Software other than in accordance with the applicable specifications provided by Skydio. Support is only available for the current and single prior major release of Advanced Software. No other services are included under this Agreement.

- 22** **Administrators.** Customer shall designate up to three (3) of its employees to administer the Services on its behalf and serve as points of contact in communicating with us, as set forth in the applicable Confirmation or as otherwise agreed by the parties in writing (“**Administrators**”). If a person named as an Administrator leaves Customer’s employ, Customer may designate another one of its employees to serve as Administrator to replace the departing employee.
- 23** **Indemnification.** Skydio will indemnify Customer’s officers, directors, and employees (“**Customer Indemnitees**”) against all claims, demands, losses, and reasonable expenses arising out of a third-party claim against an Customer Indemnitee resulting from any negligent act, error or omission, or willful misconduct by Skydio under this Agreement, except to the extent of Customer’s negligence or willful misconduct, or claims under workers compensation.
- 24** **IP Indemnification.** Skydio will indemnify Customer Indemnitees against all claims, losses, and reasonable expenses from any third-party claim alleging that the use of Skydio Products or services infringes or misappropriates the third-party’s intellectual property rights. Customer must promptly provide Skydio with written notice of such claim, tender to Skydio the defense or settlement of such claim at Skydio’s expense and cooperate fully with Skydio in the defense or settlement of such claim. Skydio’s IP indemnification obligations do not apply to claims based on (a) modification of Skydio Products or services by Customer or a third-party not approved by Skydio; (b) use of Skydio Products and services in combination with hardware or services not approved by Skydio; (c) use of Skydio Products and services other than as permitted in this Agreement; or (d) use of Skydio Software that is not the most current release provided by Skydio.
- 25** **Customer Responsibilities.** Customer is responsible for (a) Customer’s use of Skydio Products; (b) breach of this Agreement or violation of applicable law by Customer or a Customer’s authorized end user; and (c) a dispute between Customer and a third-party over Customer’s use of Skydio Products.
- 26** **Export Sales and Export Controls.** Customer acknowledges that the Skydio Products, services and technology are subject to export controls under the laws and regulations of the United States (U.S.). Customer shall comply with such laws and regulations governing use, export, re-export, and transfer of Skydio Products, services and technology and shall obtain all required U.S. and local authorizations, permits, or licenses. Skydio and Customer each agree to provide the other such information and assistance as may reasonably be required by the other in connection with securing such authorizations and licenses, and to take timely action to obtain all required supporting documentation.

\*\*\*\*  
Copyright © 2021 Skydio, Inc.

Skydio, Inc.  
114 Hazel Ave.,  
Redwood City, CA 94061  
[legal@skydio.com](mailto:legal@skydio.com)

SKYDIO is a trademark and service mark of Skydio, Inc. Visit Skydio’s Web Site at [www.skydio.com](http://www.skydio.com)

## **Axon Commander™ Software Appendix**

- 5** **License.** Axon owns all executable instructions, images, icons, sound, and text in Commander. All rights are reserved to Axon. Axon grants a non-exclusive, royalty-free, worldwide right and license

to use Commander. "Use" means storing, loading, installing, or executing Commander exclusively for data communication with an Axon Device. Agency may use Commander in a networked environment on computers other than the computer it installs Commander on, so long as each execution of Commander is for data communication with an Axon Device. Agency may make copies of Commander for archival purposes only. Agency shall retain all copyright, trademark, and proprietary notices in Commander on all copies or adaptations.

6 **Term**. The Quote will detail the duration of the Commander license, as well as any maintenance. The term will begin upon installation of Commander by Axon.

7 **License Restrictions**. All licenses will immediately terminate if Agency does not comply with any term of this Agreement. Agency may not use Commander for any purpose other than as expressly permitted by this Agreement. Agency may not:

- 7.1 modify, tamper with, repair, or otherwise create derivative works of Commander;
- 7.2 reverse engineer, disassemble, or decompile Commander or apply any process to derive the source code of Commander, or allow others to do the same;
- 7.3 access or use Commander to avoid incurring fees or exceeding usage limits or quotas;
- 7.4 copy Commander in whole or part, except as expressly permitted in this Agreement;
- 7.5 use trade secret information contained in Commander;
- 7.6 resell, rent, loan or sublicense Commander;
- 7.7 access Commander to build a competitive device or service or copy any features, functions, or graphics of Commander; or
- 7.8 remove, alter, or obscure any confidentiality or proprietary rights notices (including copyright and trademark notices) of Axon or Axon's licensors on or within Commander or any copies of Commander.

8 **Support**. Axon may make available updates and error corrections ("**Updates**") to Commander. Axon will provide Updates electronically via the Internet or media as determined by Axon. Agency is responsible for establishing and maintaining adequate access to the Internet to receive Updates. Agency is responsible for maintaining the computer equipment necessary to use Commander. Axon may provide technical support of a prior release/version of Commander for 6 months from when Axon made the subsequent release/version available.

9 **Termination**. Axon may terminate Agency's license immediately for Agency's failure to comply with any of the terms in this Agreement. Upon termination, Axon may disable Agency's right to login to Axon Commander.

---

## Axon Application Programming Interface Appendix

### 1 Definitions.

“**API Client**” means the software that acts as the interface between Agency’s computer and the server, which is already developed or to be developed by Agency.

“**API Interface**” means software implemented by Agency to configure Agency’s independent API Client Software to operate in conjunction with the API Service for Agency’s authorized Use.

“**Axon Evidence Partner API, API or AXON API**” (collectively “**API Service**”) means Axon’s API which provides a programmatic means to access data in Agency’s Axon Evidence account or integrate Agency’s Axon Evidence account with other systems.

“**Use**” means any operation on Agency’s data enabled by the supported API functionality.

### 2 Purpose and License.

**2.1** Agency may use API Service and data made available through API Service, in connection with an API Client developed by Agency. Axon may monitor Agency’s use of API Service to ensure quality, improve Axon devices and services, and verify compliance with this Agreement. Agency agrees to not interfere with such monitoring or obscure from Axon Agency’s use of API Service. Agency will not use API Service for commercial use.

**2.2** Axon grants Agency a non-exclusive, non-transferable, non-sublicensable, worldwide, revocable right and license during the Term to use API Service, solely for Agency’s Use in connection with Agency’s API Client.

**2.3** Axon reserves the right to set limitations on Agency’s use of the API Service, such as a quota on operations, to ensure stability and availability of Axon’s API. Axon will use reasonable efforts to accommodate use beyond the designated limits.

**3** **Configuration.** Agency will work independently to configure Agency’s API Client with API Service for Agency’s applicable Use. Agency will be required to provide certain information (such as identification or contact details) as part of the registration. Registration information provided to Axon must be accurate. Agency will inform Axon promptly of any updates. Upon Agency’s registration, Axon will provide documentation outlining API Service information.

**4** **Agency Responsibilities.** When using API Service, Agency and its end users may not:

**4.1** use API Service in any way other than as expressly permitted under this Agreement;

**4.2** use in any way that results in, or could result in, any security breach to Axon;

**4.3** perform an action with the intent of introducing any viruses, worms, defect, Trojan horses, malware, or any items of a destructive nature to Axon Devices and Services;

**4.4** interfere with, modify, disrupt or disable features or functionality of API Service or the servers or networks providing API Service;

**4.5** reverse engineer, decompile, disassemble, or translate or attempt to extract the source code from API Service or any related software;

**4.6** create an API Interface that functions substantially the same as API Service and offer it for use by third parties;

**4.7** provide use of API Service on a service bureau, rental or managed services basis or permit other individuals or entities to create links to API Service;

**4.8** frame or mirror API Service on any other server, or wireless or Internet-based device;

**4.9** make available to a third-party, any token, key, password or other login credentials to API Service;

**4.10** take any action or inaction resulting in illegal, unauthorized or improper purposes; or disclose Axon’s API manual.

**5** **API Content.** All content related to API Service, other than Agency Content or Agency’s API Client content, is considered Axon’s API Content, including:

- 5.1 the design, structure and naming of API Service fields in all responses and requests;
  - 5.2 the resources available within API Service for which Agency takes actions on, such as evidence, cases, users, or reports; and
  - 5.3 the structure of and relationship of API Service resources; and
  - 5.4 the design of API Service, in any part or as a whole.
- 6 **Prohibitions on API Content.** Neither Agency nor its end users will use API content returned from the API Interface to:
- 6.1 scrape, build databases, or otherwise create permanent copies of such content, or keep cached copies longer than permitted by the cache header;
  - 6.2 copy, translate, modify, create a derivative work of, sell, lease, lend, convey, distribute, publicly display, or sublicense to any third-party;
  - 6.3 misrepresent the source or ownership; or
  - 6.4 remove, alter, or obscure any confidentiality or proprietary rights notices (including copyright and trademark notices).
- 7 **API Updates.** Axon may update or modify the API Service from time to time (“**API Update**”). Agency is required to implement and use the most current version of API Service and to make any applicable changes to Agency’s API Client required as a result of such API Update. API Updates may adversely affect how Agency’s API Client access or communicate with API Service or the API Interface. Each API Client must contain means for Agency to update API Client to the most current version of API Service. Axon will provide support for 1 year following the release of an API Update for all depreciated API Service versions.



---

**Advanced User Management Appendix**

- 1 **Scope.** Advanced User Management allows Agency to (a) utilize bulk user creation and management, (b) automate user creation and management through System for Cross-domain Identity Management (“**SCIM**”), and (c) automate group creation and management through SCIM.
  
- 2 **Advanced User Management Configuration.** Agency will work independently to configure Agency’s Advanced User Management for Agency’s applicable Use. Upon request, Axon will provide general guidance to Agency, including documentation that details the setup and configuration process.

---

## Axon Channel Services Appendix

- 1 **Definitions.**

**“Axon Digital Evidence Management System”** means Axon Evidence or Axon Commander, as specified in the attached Channel Services Statement of Work.

**“Active Channel”** means a third-party system that is continuously communicating with an Axon Digital Evidence Management System.

**“Inactive Channel”** means a third-party system that will have a one-time communication to an Axon Digital Evidence Management System.
- 2 **Scope.** Agency currently has a third-party system or data repository from which Agency desires to share data with Axon Digital Evidence Management. Axon will facilitate the transfer of Agency’s third-party data into an Axon Digital Evidence Management System or the transfer of Agency data out of an Axon Digital Evidence Management System as defined in the Channel Services Statement of Work (**“Channel Services SOW”**). Channel Services will not delete any Agency Content. Agency is responsible for verifying all necessary data is migrated correctly and retained per Agency policy.
- 3 **Purpose and Use.** Agency is responsible for verifying Agency has the right to share data from and provide access to third-party system as it relates to the Services described in this Appendix and the Channel Services SOW. For Active Channels, Agency is responsible for any changes to a third-party system that may affect the functionality of the channel service. Any additional work required for the continuation of the Service may require additional fees. An Axon Field Engineer may require access to Agency’s network and systems to perform the Services described in the Channel Services SOW. Agency is responsible for facilitating this access per all laws and policies applicable to Agency.
- 4 **Project Management.** Axon will assign a Project Manager to work closely with Agency’s project manager and project team members and will be responsible for completing the tasks required to meet all contract deliverables on time and budget.
- 5 **Warranty.** Axon warrants that it will perform the Channel Services in a good and workmanlike manner.
- 6 **Monitoring.** Axon may monitor Agency’s use of Channel Services to ensure quality, improve Axon devices and services, prepare invoices based on the total amount of data migrated, and verify compliance with this Agreement. Agency agrees not to interfere with such monitoring or obscure from Axon Agency’s use of channel services.
- 7 **Agency’s Responsibilities.** Axon’s successful performance of the Channel Services requires Agency:
  - 7.1 Make available its relevant systems for assessment by Axon (including making these systems available to Axon via remote access);
  - 7.2 Provide access to the building facilities and where Axon is to perform the Channel Services, subject to safety and security restrictions imposed by the Agency (including providing security passes or other necessary documentation to Axon representatives performing the Channel Services permitting them to enter and exit Agency premises with laptop personal computers and any other materials needed to perform the Channel Services);
  - 7.3 Provide all necessary infrastructure and software information (TCP/IP addresses, node names, and network configuration) for Axon to provide the Channel Services;
  - 7.4 Ensure all appropriate data backups are performed;
  - 7.5 Provide Axon with remote access to the Agency’s network and third-party systems when required for Axon to perform the Channel Services;
  - 7.6 Notify Axon of any network or machine maintenance that may impact the performance of



- the Channel Services; and
- 7.7** Ensure the reasonable availability by phone or email of knowledgeable staff, personnel, system administrators, and operators to provide timely, accurate, complete, and up-to-date documentation and information to Axon (these contacts are to provide background information and clarification of information required to perform the Channel Services).

---

## VIEVU Data Migration Appendix

- 1 **Scope.** Agency currently has legacy data in the VIEVU Solution from which Agency desires to move to Axon Evidence. Axon will work with Agency to copy legacy data from the VIEVU solution into Axon Evidence (“**Migration**”). Before Migration, Agency and Axon will work together to develop a Statement of Work (“**Migration SOW**”) to detail all deliverables and responsibilities. The Migration will require the availability of Agency resources. Such resources will be identified in the SOW. On-site support during Migration is not required. Upon Agency’s request, Axon will provide on-site support for an additional fee. Any request for on-site support will need to be pre-scheduled and is subject to Axon’s resource availability.

A small amount of unexposed data related to system information will not be migrated from the VIEVU solution to Axon Evidence. Upon request, some of this data can be manually exported before Migration and provided to Agency. The Migration SOW will provide further detail.

- 2 **Changes.** Axon is only responsible to perform the Services described in this Appendix and Migration SOW. Any additional services are out of scope. The Parties must document scope changes in a written and signed change order. Changes may require an equitable adjustment in the charges or schedule.
- 3 **Project Management.** Axon will assign a Project Manager to work closely with Agency’s project manager and project team members and will be responsible for completing the tasks required to meet all contract deliverables on time and budget.
- 4 **Downtime.** There may be downtime during the Migration. The duration of the downtime will depend on the amount of data that Agency is migrating. Axon will work with Agency to minimize any downtime. Any VIEVU mobile application will need to be disabled upon Migration.
- 5 **Functionality Changes.** Due to device differences between the VIEVU solution and the Axon’s Axon Evidence solution, there may be functionality gaps that will not allow for all migrated data to be displayed the same way in the user interface after Migration
- 6 **Acceptance.** Once the Migration is complete, Axon will notify Agency and an acceptance form. Agency is responsible for verifying that the scope of the project has been completed and all necessary data is migrated correctly and retained per Agency policy. Agency will have 90 days to provide Axon acceptance that the Migration was successful, or Axon will deem the Migration accepted.

In the event Agency does not accept the Migration, Agency agrees to notify the Axon within a reasonable time. Agency also agrees to allow Axon a reasonable time to resolve any issue. In the event Agency does not provide the Axon written rejection of the Migration during these 90 days, Agency may be charged for additional monthly storage costs. After Agency provides acceptance of the Migration, the Axon will delete all data from the VIEVU solution 90 days after the Migration.

- 7 **Post-Migration.** After Migration, the VIEVU solution may not be supported and updates may not be provided. Axon may end of life the VIEVU solution in the future. If Agency elects to maintain data within the VIEVU solution, Axon will provide Agency 90 days’ notice before ending support for the VIEVU solution.
- 8 **Warranty.** Axon warrants that it will perform the Migration in a good and workmanlike manner.
- 9 **Monitoring.** Axon may monitor Agency’s use of Migration to ensure quality, improve Axon devices and services, prepare invoices based on the total amount of data migrated, and verify compliance with this Agreement. Agency agrees not to interfere with such monitoring or obscure from Axon Agency’s use of Migration.

**Axon Support Engineer Appendix**

- 1 **Axon Support Engineer Payment.** Axon will invoice for Axon Support Engineer (“ASE”) services, as outlined in the Quote, when the Axon Support Engineer commences work on-site at Agency.
- 2 **Full-Time ASE Scope of Services.**
  - 2.1 A Full-Time ASE will work on-site four (4) days per week.
  - 2.2 Agency’s Axon sales representative and Axon’s Agency Success team will work with Agency to define its support needs and ensure the Full-Time ASE has skills to align with those needs. There may be up to a 6-month waiting period before the Full-Time ASE can work on-site, depending upon Agency’s needs and availability of a Full-Time ASE.
  - 2.3 The purchase of Full-Time ASE Services includes 2 complimentary Axon Accelerate tickets per year of the Agreement, so long as the ASE has started work at Agency, and Agency is current on all payments for the Full-Time ASE Service.

The Full-Time ASE Service options are listed below:

<b>Ongoing System Set-up and Configuration</b> <ul style="list-style-type: none"><li>• Assisting with assigning cameras and registering docks</li><li>• Maintaining Agency’s Axon Evidence account</li><li>• Connecting Agency to “Early Access” programs for new devices</li></ul>
<b>Account Maintenance</b> <ul style="list-style-type: none"><li>• Conducting on-site training on new features and devices for Agency leadership team(s)</li><li>• Thoroughly documenting issues and workflows and suggesting new workflows to improve the effectiveness of the Axon program</li><li>• Conducting weekly meetings to cover current issues and program status</li></ul>
<b>Data Analysis</b> <ul style="list-style-type: none"><li>• Providing on-demand Axon usage data to identify trends and insights for improving daily workflows</li><li>• Comparing Agency's Axon usage and trends to peers to establish best practices</li><li>• Proactively monitoring the health of Axon equipment and coordinating returns when needed</li></ul>
<b>Direct Support</b> <ul style="list-style-type: none"><li>• Providing on-site, tier 1 and tier 2 technical support for Axon devices</li><li>• Proactively monitoring the health of Axon equipment</li><li>• Creating and monitoring RMAs on-site</li><li>• Providing Axon app support</li><li>• Monitoring and testing new firmware and workflows before they are released to Agency’s production environment</li></ul>
<b>Agency Advocacy</b> <ul style="list-style-type: none"><li>• Coordinating bi-annual voice of customer meetings with Axon’s Device Management team</li><li>• Recording and tracking Agency feature requests and major bugs</li></ul>

- 3 **Regional ASE Scope of Services**
  - 3.1 A Regional ASE will work on-site for 3 consecutive days per quarter. Agency must schedule the on-site days at least 2 weeks in advance. The Regional ASE will also be available by phone and email during regular business hours up to 8 hours per week.
  - 3.2 There may be up to a 6-month waiting period before Axon assigns a Regional ASE to Agency, depending upon the availability of a Regional ASE.
  - 3.3 The purchase of Regional ASE Services includes 2 complimentary Axon Accelerate tickets per year of the Agreement, so long as the ASE has started work at Agency and Agency is current on all payments for the Regional ASE Service.

The Regional ASE service options are listed below:



## Master Services and Purchasing Agreement between Axon and Agency (Online)

### Account Maintenance

- Conducting remote training on new features and devices for Agency's leadership
- Thoroughly documenting issues and workflows and suggesting new workflows to improve the effectiveness of the Axon program
- Conducting weekly conference calls to cover current issues and program status
- Visiting Agency quarterly (up to 3 consecutive days) to perform a quarterly business review, discuss Agency's goals for your Axon program, and continue to ensure a successful deployment of Axon devices

### Direct Support

- Providing remote, tier 1 and tier 2 technical support for Axon devices
- Creating and monitoring RMAs remotely

### Data Analysis

- Providing quarterly Axon usage data to identify trends and program efficiency opportunities
- Comparing an Agency's Axon usage and trends to peers to establish best practices
- Proactively monitoring the health of Axon equipment and coordinating returns when needed

### Agency Advocacy

- Coordinating bi-yearly Voice of Agency meetings with Device Management team
- Recording and tracking Agency feature requests and major bugs

- 4** **Out of Scope Services.** The ASE is responsible to perform only the Services described in this Appendix. Any additional Services discussed or implied that are not defined explicitly in this Appendix will be considered out of the scope.
- 5** **ASE Leave Time.** The ASE will be allowed up 7 days of sick leave and up to 15 days of vacation time per each calendar year. The ASE will work with Agency to coordinate any time off and will provide Agency with at least 2 weeks' notice before utilizing any vacation days.



August 18, 2021  
Our 92nd Year

**Ship To:**  
CITY OF OXFORD (GA)  
105 W WATSON ST  
OXFORD, GA 30054  
US

**Bill To:**  
CITY OF OXFORD (GA)  
110 W CLARK ST  
OXFORD, GA 30054  
United States

Attn:  
Phone:  
Email:

**Altec Quotation Number:** 959266 - 1  
**Account Manager:** Tim Luker  
**Technical Sales Rep:** Jeff Atkins

<u>Item</u>	<u>Description</u>	<u>Qty</u>	<u>Price</u>
	<u>Unit</u>		
1.	ALTEC Model DM47B; 47 foot Digger Derrick with hydraulic extending full capacity intermediate and upper booms. Built in accordance with standard specifications and to include the following features:	1	
	<ul style="list-style-type: none"> <li>A. Pole Setting Sheave Height: 46.4 feet</li> <li>B. Maximum Horizontal Reach from centerline of rotation: 37.0 feet</li> <li>C. Digging Radius from centerline of rotation: 17.9 to 26.7 feet</li> <li>D. Lift Capacity at 10 Ft. Radius: 12,340 lbs. (Without optional equipment installed). See complete load chart for capacities with installed options.</li> <li>E. Boom Articulation: -20 to 80 degrees</li> <li>F. Continuous Rotation with high capacity worm gear drive gearbox</li> <li>G. Insulated, 46 KV and below</li> <li>H. Hydraulic Overload Protection (HOP) System: activates when the unit is exposed to an overload condition. System prevents actuation of all functions that could increase the overload condition. System automatically resets when overload condition is relieved. Overload protected functions include:               <ul style="list-style-type: none"> <li>- Boom Lower</li> <li>- Intermediate Boom Extend</li> <li>- Third Stage Boom Extend</li> <li>- Winch Raise</li> <li>- Digger Dig</li> </ul> </li> <li>I. Load Indicator Gauge: located at the main control panel, displays the percentage of total allowable lifting capacity being utilized. By use of this gauge, the operator is aware of the hydraulic and structural design rating of the derrick and proximity to the limits during operation.</li> <li>J. Electronic Controls: Intuitive electronic controls with superior metering. Includes a diagnostic port which by connecting a handheld service tool, provides troubleshooting code readouts and the ability to calibrate function speeds and control sensitivity. Electric controls eliminate the risk of high pressure hose leaks near the operator and leak points are minimized throughout the machine.</li> <li>K. Manual override of electronically controlled boom, winch, and digger functions at the main control valve</li> <li>L. Standard/Low Speed Selector: Allows operator to select standard or low function</li> </ul>		

<u>Item</u>	<u>Description</u>	<u>Qty</u>	<u>Price</u>
	speed operation. When in standard mode, each function operates at normal speeds. When in low speed, the maximum operational speed of each function is slower providing finer feathering capability. The function is separate from engine throttle control.		
M.	Remote Control Retrofittable: Control system includes single quick connect plug for quick and easy installation of radio remote control system in the field upon request (if not already equipped).		
N.	Proportional Hydraulic Control System: Closed Center Hydraulic control valve for boom, winch, and digger functions are operated and controlled by a proportional pilot system which provides full metering and feathering characteristics.		
O.	Hydraulic System: Closed Center hydraulic system with maximum flow of 43 gpm for simultaneous operation of multiple functions. Flow is provided by a variable displacement, pressure compensated, piston pump. This 'flow on demand' system optimizes the overall system efficiency. System is designed with compensators in each valve section for smooth transitions between functions. Maximum system pressure is 3000 psi. Because flow is provided by a single source (piston pump), maximum flow is available to any combination of functions including simultaneous operation of the boom and digger/winch functions and flow combining is not necessary.		
P.	Fiberglass hydraulic upper boom and boom tip with provision for platform attachment.		
Q.	Transferable Hydraulic Pole Guides and Steel Boom Flares at the boom tip with adjustable alignment guides. Pole guides are hydraulically powered for open, close, and tilt.		
R.	Pole Guide Tilt Interlock: Prevents the upper boom from extending when the transferable guides are attached to the intermediate boom until the proximity sensors detect that the guides are tilted all the way up and out of the way.		
S.	Bearings: All extending booms utilize self lubricating, low friction, slide bearings.		
T.	Boom Stow Protection System: A proximity switch on main boom detects the boom support as the boom is being stored and limits the boom down function to avoid excessive down force into the stow.		
U.	Auger Stow Protection: Limits the upward travel of the auger as it reaches the top of the auger stow latch to prevent an overstow condition.		
V.	Two-part load line attachment point on the intermediate boom		
W.	Unit is painted with a powder coat paint process which provides a finish-painted surface that is highly resistant to chipping, scratching, abrasion and corrosion.		
X.	Structural Warranty: all of the following applicable major components is to be warranted for so long as the initial purchaser owns the product: Booms, boom articulation links, hydraulic cylinder structures, outrigger weldments, pedestals, subbases and turntables.		
Y.	Manuals: Two (2) operator and Maintenance/Parts manuals		
2.	Rear mount pedestal	1	
3.	Rear Mount - Traditional Control Seat, installed on curb side of turntable, includes single control station	1	
4.	Turntable Mounted Winch	1	
5.	Winch: Normal Speed with 15,000 lbs. bare drum capacity.	1	
6.	Digger, Two-Speed Mechanical Shift, 12,000 ft-lbs. Includes a rapid reversing shake feature for quick and convenient cleaning of dirt from the auger and all of the components necessary to operate digger, installed.	1	

We Wish To Thank You For Giving Us The Pleasure  
And Opportunity of Serving You

UTILITY EQUIPMENT AND BODIES SINCE 1929

<u>Item</u>	<u>Description</u>	<u>Qty</u>	<u>Price</u>
7.	2.50 in Hex Output Shaft With 2.50 in Hex Extension Shaft	1	
8.	Digger Storage: located on the Street Side (Normal) with Nylon auger wind up strap (NOTE: for behind the cab mount derricks, the digger will be located on the curbside)	1	
9.	Derrick is Not Rated for Platform Use: Unit is designed and tested for use only as a digger derrick.	1	
10.	Standard Hydraulic Side Load Protection: relieves overload conditions by allowing rotation system to back drive.	1	
11.	Code 450 Outriggers, A-frame, folding shoe, 153 maximum spread, for use as auxiliary or primary outriggers	1	
	<ul style="list-style-type: none"> <li>A. Maximum Spread: 153 inches measured from centerline of shoe pins</li> <li>B. Penetration at maximum extension: 6.5 inches (for standard installation on a 40 inch frame height)</li> <li>C. Standard Shoe Dimensions: 14 x 15.25 inches</li> <li>D. Hydraulic Outrigger Control Valves</li> <li>E. Outrigger/Unit Selector Control: Reduces the potential for inadvertent outrigger movement during machine operation if outrigger controls are bumped.</li> <li>F. Outrigger motion alarms</li> <li>G. Outrigger Interlocks: will not allow the unit to be operated until the outriggers have been at least partially deployed.</li> </ul>		
12.	450 - Outriggers, A-frame, folding shoe, 153 maximum spread, for use as auxiliary outriggers on all units or primary outriggers on select units, includes:	1	
	<ul style="list-style-type: none"> <li>A. Maximum Spread: 153 inches measured from centerline of shoe pins</li> <li>B. Penetration at maximum extension: 6.5 inches (for standard installation on a 40 inch frame height)</li> <li>C. Standard Shoe Dimensions: 14 x 15.25 inches</li> <li>D. Hydraulic Outrigger Control Valves</li> <li>E. Outrigger/Unit Selector Control: Reduces the potential for inadvertent outrigger movement during machine operation if outrigger controls are bumped.</li> <li>F. Outrigger motion alarms</li> <li>G. Outrigger Interlocks: Will not allow the unit to be operated until the outriggers have been at least partially deployed.</li> </ul>		
13.	Powder coat unit Altec White.	1	
<b><u>Unit &amp; Hydraulic Acc.</u></b>			
14.	Unit Installation Components.	1	
15.	Dirt Auger, 18" DIA, With 2-1/2" Hex X 104" L (Pro-Dig)	1	
16.	Winch Rope For Turntable Winch	1	
17.	Load Line Swivel Hook, 8-1/2 Ton (Crosby)	1	
18.	Standard Spacer between Subbase and frame for hose routing and ease of maintenance.	1	
19.	DL/DM, DC Series Derrick Subbase (Rigid)	1	

We Wish To Thank You For Giving Us The Pleasure  
And Opportunity of Serving You

UTILITY EQUIPMENT AND BODIES SINCE 1929

<u>Item</u>	<u>Description</u>	<u>Qty</u>	<u>Price</u>
20.	Subbase Storage With Drop Down Door (Paddle Latch) At Rear Notched for Tool Storage	1	
21.	Reservoir, 60 Gallon, (Altec Standard)	1	
22.	Hydraulic components needed when locating reservoir more than 86" from pump.	1	
23.	HVI-22 Hydraulic Oil (Standard).	65	
24.	Standard Pump For PTO	1	
25.	Hot shift PTO for automatic transmission	1	
26.	Muncie PTO (Altec Standard)	1	
27.	Standard PTO/Transmission Functionality for Automatic Transmissions -If chassis is in gear, and PTO switch is activated, PTO will not engage. Chassis will remain in gear. Once the chassis is shifted back into gear the PTO will disengage. For some truck configurations the PTO switch must be turned off to allow the transmission to shift into gear.	1	
28.	Spring Loaded Hose Reel, 50 FT Hose Capacity	1	
29.	Install Tool Circuit For Hose Reel Installation, Below Rotation (Male Pressure, Female Return -Installed at Hose Reel)	1	
30.	50' Non-Conductive Hose Kit, Orange, Includes Quick Disconnects and Dust Caps (Male Pressure, Female Return)	1	

**Body**

31.	142 inch Universal Bobtail Service Line Body, suitable for installing on any 4x2 chassis with an approximate CA dimension of 120 inches, built in accordance with the following specifications:	1	
	<b>A.</b> Basic body fabricated from A40 grade 100% zinc alloy steel.		
	<b>B.</b> All doors are full, double paneled, self-sealed with built-in drainage for maximum weather-tightness. Stainless steel hinge rods extend full length of door.		
	<b>C.</b> All doors are to contain stainless steel flush type, single point, two-stage rotary paddle latches with recessed handles, including keyed locks and strikers. door latches are bolted to the outer door panel.		
	<b>D.</b> Heavy-gauge welded steel frame construction with smooth floor with lattice understructure.		
	<b>E.</b> Possible contact edges are folded for safety.		
	<b>F.</b> Integrated door header drip rail at top for maximum weather protection.		
	<b>G.</b> Fender panels are either roll formed or have neoprene fenderettes mechanically fastened.		
	<b>H.</b> Steel treated for improved primer bond and rust resistance.		
	<b>I.</b> Automotive underseal applied to entire underside of body.		
	<b>J.</b> Primer applied to complete interior and exterior of body.		
	<b>K.</b> Automotive type non-porous door seals fastened to the door facing.		
	<b>L.</b> 142 inch overall body length.		
	<b>M.</b> 94 inch overall body width.		
	<b>N.</b> 46 inch overall body height.		

We Wish To Thank You For Giving Us The Pleasure  
And Opportunity of Serving You

UTILITY EQUIPMENT AND BODIES SINCE 1929

<u>Item</u>	<u>Description</u>	<u>Qty</u>	<u>Price</u>
O.	18 inch body compartment depth.		
P.	Finish paint body Altec White at body manufacturer.		
Q.	2 inch x 6 inch drop-in wooden cargo retaining board at rear of body.		
R.	2 inch x 6 inch drop-in wooden cargo retaining board at top of side access step.		
S.	Gas shock type rigid door holders for vertical doors.		
T.	Standard master body locking system.		
U.	One (1) wheel chock holder installed in fender panel on each side of body.		
V.	Hotstick shelf extending full length of body on streetside.		
W.	Two (2) hotstick brackets installed on streetside.		
X.	Standard size bottom-hinged hotstick door installed on streetside.		
Y.	1st vertical streetside (LH) - Three (3) adjustable shelves with removable dividers on 4 inch centers.		
Z.	2nd vertical streetside (LH) -Six (6) locking swivel hooks on adjustable rails. 1-4-1 configuration.		
AA.	3rd vertical streetside (LH) - Six (6) locking swivel hooks on adjustable rails. 1-4-1 configuration.		
AB.	1st horizontal streetside (LH) - One (1) adjustable shelf with slots, no dividers provided.		
AC.	1st vertical curbside (RH) - Six (6) locking swivel hooks on adjustable rails. 1-4-1 configuration.		
AD.	2nd vertical curbside (RH) - Gripstrut access steps with two (2) sloped grab handles.		
AE.	3rd vertical curbside (RH) - Six (6) locking swivel hooks on adjustable rails. 2-2-2 configuration.		
AF.	1st horizontal curbside (RH) - Two (2) adjustable shelves with removable dividers on 8 inch centers.		
AG.	Compartment top access step installed on curbside.		
AH.	34 inch long x 94 inch wide steel tailshelf, with 3 inch high retainer rail around sides and rear, installed at rear of body.		
AI.	Four (4) recessed D-rings installed in body floor, one (1) at each corner.		

**Body and Chassis Accessories**

32.	ICC (Underride Protection) Bumper Installed At Rear	1	
33.	T-125 Style Pintle Hitch (30,000 LB MGTW with 6,000 LB MVL)	1	
34.	Set Of Eye Bolts for Trailer Safety Chain, installed one each side of towing device mount.	1	
35.	Glad Hands At Rear, Straight Type	1	
36.	Rigid Step Mounted Beneath Side Access Steps (Installed To Extend Approx. 2" Outward)	1	
37.	Riding Seat Access Step (For Derricks)	1	
38.	Lower Boom Rest Weldment	1	
39.	Mounting Brackets for Lights, Located on Lower Boom Rest	1	
40.	Wood Outrigger Pad, 24 x 24 x 2.5 Inch, With Rope Handle	4	
41.	Outrigger Pad Holder, 25" L x 25" W x 5" H, Fits 24.5" x 24.5" x 4" And Smaller Pads,	4	

We Wish To Thank You For Giving Us The Pleasure  
And Opportunity of Serving You

UTILITY EQUIPMENT AND BODIES SINCE 1929

<u>Item</u>	<u>Description</u>	<u>Qty</u>	<u>Price</u>
	Bolt-On, Bottom Washout Holes, 3/4" Lip Retainer		
42.	Pendulum Retainers For Outrigger Pad Holders	4	
43.	Mud Flaps With Altec Logo (Pair)	1	
44.	Wheel Chocks, Rubber, 9.75" L x 7.75" W x 5.00" H, with 4" L Metal Hairpin Style Handle (Pair)	1	
45.	Wheel Chock Holders (Pair), For Installation Under Flatbed Or Dump Body	1	
46.	Dock Bumpers (Pair), Fixed Mounting (Rectangular Bumper), Installed At Rear	1	
47.	Slope Indicator Assembly (Pair) For Machine With Outriggers	1	
48.	Pole Rack, Two Pole Capacity With Semi-Ratchet Tie Binders, Ratchet Cap and Cheater Bar (Behind The Cab Mount)	1	
49.	5 LB Fire Extinguisher With Light Duty Bracket, Installed (In Cab or Inside Compartment Only)	1	
50.	Triangular Reflector And Flare Kit [Contains 3 Reflectors And 3 Flares/Fuses (20 Minutes Each)], Shipped Per DEPS-0042	1	
51.	Vinyl manual pouch for storage of all operator and parts manuals	1	
<b><u>Electrical Accessories</u></b>			
52.	Lights and reflectors in accordance with FMVSS #108 lighting package. (Complete LED, including LED reverse lights)	1	
53.	Altec Standard Amber LED Strobe Light with Brush Guard	2	
54.	Dual Tone Back-Up With Outrigger Motion Alarm	1	
55.	Altec Standard Multi-Point Grounding System	6	
56.	Copper U Shaped Grounding Lug (Threaded)	2	
57.	7-Way Trailer Receptacle (Pin Type) Installed At Rear	1	
58.	Relocate Trailer Receptacle Supplied With Chassis	1	
59.	Electric Trailer Brake Controller (Draw-Tite Activator II #5504)	1	
60.	Altec Modular Panel System (AMPS) - Includes Mounting Panel and Accessory Switches	1	
61.	Pre-Wire Power Distribution Module 10 is a compact self-contained electronic system that provides a standardized interface with the chassis electrical system.	1	
<b><u>Finishing Details</u></b>			
62.	Powder Coat Unit Altec White	1	

We Wish To Thank You For Giving Us The Pleasure  
And Opportunity of Serving You

UTILITY EQUIPMENT AND BODIES SINCE 1929



<u>Item</u>	<u>Description</u>	<u>Qty</u>	<u>Price</u>
63.	Finish Paint Body Accessories Above Body Floor Altec White	1	
64.	Altec Standard; Components mounted below frame rail shall be coated black by Altec. i.e. step bumpers, steps, frame extension, pintle hook mount, dock bumper mounts, D-rings, receiver tubes, accessory mounts, light brackets, under-ride protection, etc. Components mounted to under side of body shall be coated black by Altec. i.e. Wheel chock holders, mud flap brackets, pad carriers, boxes, lighting brackets, steps, and ladders.	1	
65.	Apply Non-Skid Coating to all walking surfaces	1	
66.	English Safety And Instructional Decals	1	
67.	Vehicle Height Placard - Installed In Cab	1	
68.	Placard, HVI-22 Hydraulic Oil	1	
69.	Dielectric test unit according to ANSI requirements.	1	
70.	Stability test unit according to ANSI requirements.	1	
71.	Focus Factory Build	1	
72.	Delivery Of Completed Unit	1	
73.	Inbound Freight	1	
74.	As Built Electrical And Hydraulic Schematics To Be Included In The Manual Pouch	1	
75.	DM47B-TR RS, No Uppers, Line Body, Differential Lock, Freightliner M-2, 4x2, Automatic Transmission	1	
76.	Stock Unit	1	
77.	Stock Unit Sold To Customer	1	
<b><u>Chassis</u></b>			
78.	Altec Supplied Chassis	1	
79.	Altec Stock Chassis	1	
	A. Altec Supplied Chassis		
	B. 2023 Model Year		
	C. Freightliner M2-106		
	D. 4x2		
	E. 122" Clear CA (Round To Next Whole Number)		
	F. Regular Cab		
	G. Chassis Cab		
	H. 190" Wheelbase		
	I. Cummins B6.7		
	J. 250 HP Engine Rating		
	K. Allison 3500 RDS Automatic Transmission (Left and Right Side PTO Openings Only)		
	L. 33,000 LBS GVWR		

We Wish To Thank You For Giving Us The Pleasure  
And Opportunity of Serving You

UTILITY EQUIPMENT AND BODIES SINCE 1929

<u>Item</u>	<u>Description</u>	<u>Qty</u>	<u>Price</u>
M.	14,600 LBS Front GAWR		
N.	21,000 LBS Rear GAWR		
O.	315/80R22.5 Front Tire		
P.	11R22.5 Rear Tire		
Q.	Air Brakes		
R.	Park Brake In Rear Wheels		
S.	016-1C3 - Freightliner Horizontal Exhaust (Right-Horizontal-Under Cab-Horizontal) (Preferred) (BOC Protrusion Dependent on HP, consult Engineering)		
T.	Freightliner Upgraded Chassis Multiplex Unit (335-004)		
U.	Freightliner - Rear Cab Crossmember Flush With Back Of Cab (561-010)		
V.	Freightliner - Clear Area Around Allison PTO Openings (362-1Y0) and (363-011)		
W.	Freightliner - Clear Frame Rails From Back Of Cab To Front Rear Suspension Bracket (607-001)		
X.	Freightliner DEF Pump Mounting (23Y-001)		
Y.	Freightliner Transmission Dipstick Tube Enters Curbside of Transmission (346-013)		
Z.	Freightliner PTO Throttle Wiring for Automatic Transmission with Pre-Wire (163-001), (148-074), (87L-003)		
AA.	Freightliner/Allison Body Builder Connection with Pre-Wire (34C-002)		
AB.	Freightliner - Electric Brake Controller Wiring With Combined Stop/Turn Signal Heavy Duty Tail Light Wiring At EOF (296-027)		
AC.	Freightliner - Radiator (950 Square Inch) for ISB/B.7/DD8 (SS, 260-330HP) (266-078)		
AD.	Freightliner - Pre-Wire Chassis with Cab Backwall Pass-Thru (33U-001)		
AE.	204-215 Freightliner 50 Gallon Fuel Tank (Left Hand Under Cab)		
AF.	23U-001, 43X-002 Freightliner 6 Gallon DEF Tank (Under Cab Left Hand)		
AG.	Air Conditioning		
AH.	Cruise Control		
AI.	Tilt Steering Wheel		
AJ.	AM/FM Radio		
AK.	Bluetooth		
AL.	Driver Controlled Locking Differential		

**Additional Pricing**

80.	Standard Altec Warranty: One (1) year parts warranty, one (1) year labor warranty, ninety (90) days warranty for travel charges, limited lifetime structural warranty	1	
-----	---	---	--

<b>Unit / Body / Chassis Total</b>	<b>207,290.00</b>
<b>FET Total</b>	<b>0.00</b>
<b>Total</b>	<b>207,290.00</b>

Altec Industries, Inc.

BY \_\_\_\_\_

---

Jeff Atkins

**Notes:**

1 Altec takes pride in offering solutions that provide a safer work environment for our customers. In an effort to focus on safety, we would encourage you to consider the following items:

Outrigger pads (When Applicable)  
Fall Protection System  
Fire extinguisher/DOT kit  
Platform Liner (When Applicable)  
Altec Sentry Training  
Wheel Chocks

The aforementioned equipment can be offered in our new equipment quotations. If you find that any of these items have not been listed as priced options with an item number in the body of your quotation and are required by your company, we would encourage you to contact your Altec Account Manager and have an updated quote version sent to you. These options must be listed with an item number in the quotation for them to be supplied by Altec.

2 The final fully loaded weight of the truck and structural ratings of the hitch assembly may reduce the towing capacity and the vertical load capacity of the finished truck. These capacities may not match the ratings of the chassis or hitch.

3 Altec Standard Warranty:

One (1) year parts warranty.

One (1) year labor warranty.

Ninety (90) days warranty for travel charges.

Warranty on structural integrity of the following major components is to be warranted for so long as the initial purchaser owns the product: Booms, boom articulation links, hydraulic cylinder structures, outrigger weldments, pedestals, subbases and turntables.

Altec is to supply a self-directed, computer based training (CBT) program. This program will provide basic instruction in the safe operation of this aerial device. This program will also include and explain ANSI and OSHA requirements related to the proper use and operation of this unit.

Altec offers its standard limited warranty with the Altec supplied components which make up the Altec Unit and its installation, but expressly disclaims any and all warranties, liabilities, and responsibilities, including any implied warranties of fitness for a particular purpose and merchantability, for any customer supplied parts

Altec designs and manufactures to applicable Federal Motor Vehicle Safety and DOT standards

4 F.O.B. - #FOB\_TERMS#

5 Altec Extended Warranty Option:

An Altec Extended Warranty is an extension of Altec's Limited Warranty and protects you from the repair cost associated with defects of materials and workmanship after the standard Limited Warranty expires.

Altec offers many types of coverages and coverage packages. Ask your Altec account manager for details. Quotes are available upon request.

- 6 Unless otherwise noted, all measurements used in this quote are based on a 40 inch (1016mm) chassis frame height and standard cab height for standard configurations.
- 7 Changes made to this order may affect whether or not this vehicle is subject to F.E.T. A review will be made at the time of invoicing and any applicable F.E.T. will be added to the invoice amount.
- 8 Altec values your data privacy. The Altec Family of Companies (including Altec, Inc., and its subsidiaries) may collect telematics data from the equipment you own. Please review Altec's Equipment Data Privacy Notice on [www.altec.com](http://www.altec.com) for more information. By purchasing equipment from Altec, you consent to Altec's right to collect and use such data.
- 9 Price does not reflect any local, state or Federal Excise Taxes (F.E.T). The quote also does not reflect any local title or licensing fees. All appropriate taxes will be added to the final price in accordance with regulations in effect at time of invoicing.
- 10 Interest charge of 1/2% per month to be added for late payment.
- 11 Any payment made by a credit card may be subject to a surcharge fee.
- 12 Delivery: days after receipt of order PROVIDING:  
A. Order is received within 14 days from the date of the quote. If initial timeframe expires, please contact your Altec representative for an updated delivery commitment.  
B. Customer supplied chassis is received a minimum of sixty (60) days before scheduled delivery.  
C. Customer approval drawings are returned by requested date.  
D. Customer supplied accessories are received by date necessary for compliance with scheduled delivery.  
E. Customer expectations are accurately captured prior to major components being ordered (body, chassis) and line set date. Unexpected additions or changes made after this time or at a customer inspection will delay the delivery of the vehicle.
- Altec reserves the right to change suppliers in order to meet customer delivery requirements, unless specifically identified, by the customer, during the quote and or ordering process.
- 13 Trade-in offer is conditional upon equipment being maintained to DOT (Department of Transportation) operating and safety standards and remaining in compliance of DOT until arrival at an Altec Facility. This will include, but is not limited to engine, tires, lights, brakes, glass, etc. All equipment, i.e., jibs, winches, pintle hooks, trailer connectors, etc., are to remain with unit unless otherwise agreed upon in writing by both parties. ALTEC Industries reserves the right to re-negotiate its trade-in offer if these conditions are not met.
- All reasonable and necessary expenses required of ALTEC Industries to execute transportation of the trade-in will be invoiced to the customer for payment if these conditions are not met to maintain DOT standards.
- Customer may exercise the option to rescind this agreement in writing within sixty (60) days after receipt of purchase order. After that time ALTEC Industries will expect receipt of trade-in vehicle upon delivery of new equipment as part of the terms of the purchase order unless other arrangements have been made.
- 14 This quotation is valid until #EXPIRE\_DATE#. After this date, please contact Altec Industries, Inc. for a possible extension.
- 15 After the initial warranty period, Altec Industries, Inc. offers mobile service units, in-shop service and same day parts shipments on most parts from service locations nationwide at an additional competitive labor and parts rate. Call 877-GO-ALTEC for all of your Parts and Service needs.
- 16 FINANCING AVAILABLE: Please contact Altec Capital at (888) 408-8148 or email [finance@altec.com](mailto:finance@altec.com) for more information.
- 17 Please direct all questions to Tim Luker at

We Wish To Thank You For Giving Us The Pleasure  
And Opportunity of Serving You

UTILITY EQUIPMENT AND BODIES SINCE 1929



# TEREX®

## CUSTOMER ORDER ACKNOWLEDGEMENT

Terex Utilities, Inc. - 3140 15th Avenue SE - Watertown, SD 57201 - Phone: 605-882-4000

Date: **9/3/2021**      Sourcewell Contract Number: 012418-TER  
 Ref. Sourcewell Quote QU14251  
 Quote Number: QU16835      Unit: C4047

**City of Oxford**  
 110 West Clark Street  
 Oxford, Georgia 30054  
 404-725-6519  
 Attention: Jody Reid

**Baseline Price: \$226,443**

**Grand Total Each: \$226,443**

Prices are subject to change until shipment. Applicable taxes and surcharges will be added. Taxes, shipping & handling and lead times are estimates and subject to change. Quoted prices are based on total quoted package and subject to change if all items not purchased. All prices quoted are in U.S. dollars unless otherwise specified. Payment by cash or certified check only. Chassis payment is due upon chassis receipt at our facility. Quote withdrawn after 30 days.

Please ensure the accuracy of the specifications and drawings you provide. Changes made after receipt of order may incur additional charges. If you are trading equipment in, you warrant that: You have good title to the trade-in; it is free of all liens and encumbrances; all information you have provided related to the trade-in is true and correct.

Terex purchased chassis through Terex preferred International Dealer will include at no additional cost a special tow package for 12 months/unlimited mileage to nearest International Dealership for a warrantable failure. Coverage limited to \$550 per incident. Roadside assistance call 1-800-448-7825

Terex purchased chassis through Terex preferred Freightliner Dealer will include at no additional cost a special tow package for 12 months/unlimited mileage/KM extended towing coverage \$550 cap FEX applies. Roadside assistance call 1-800-FTL-HELP

**Notes:**

- 1) Delivery Terms are: CPT Destination
- 2) Terms: Net 30 days
- 3) Delivery days from receipt of order shall be 360+

**Buyer hereby agrees to purchase the products in this quotation, subject to acceptance by Seller. Buyer has read and agrees to Seller's Terms and Conditions of Sale.**

Terex Utilities Inc.

*Kyle Crom*  
 Sales Coordinator

*Tony Mills*  
 Account Manager

**⚠WARNING** Cancer and Reproductive Harm  
[www.P65Warnings.ca.gov](http://www.P65Warnings.ca.gov)

Accepted By: \_\_\_\_\_

PO Number: \_\_\_\_\_

Quantity: \_\_\_\_\_

Grand Total: \_\_\_\_\_

Date: \_\_\_\_\_



**TERMS AND CONDITIONS OF SALE**  
**TEREX SOUTH DAKOTA, INC./TEREX UTILITIES, INC.**  
**U.S. and CANADA (except Quebec)**

**1. Terms and Conditions.** The provision by Seller to Buyer of any Equipment or Parts (collectively referred to as “Products”) shall be exclusively governed by these Terms and Conditions of Sale (“Terms and Conditions”) and Seller’s sales order acknowledgement (collectively referred to as “Agreement”). This Agreement cancels and supersedes any and all terms and conditions previously issued by Seller and shall remain in effect unless and until superseded in writing by Seller. Acceptance of an order for Products by Seller shall be deemed to constitute a binding agreement between the parties pursuant to these Terms and Conditions and Buyer agrees that the order may not thereafter be countermanded or otherwise changed without the explicit prior written consent of Seller. No other terms and conditions shall apply, including the terms of any purchase order submitted to Seller by Buyer, whether or not objected to by Seller or whether or not such terms are inconsistent or conflict with or are in addition to these Terms and Conditions. These Terms and Conditions shall be deemed accepted by Buyer if any of the following occurs: (i) if confirmed by Buyer, (ii) if undisputed by Buyer within ten (10) days after receipt, or (iii) if Seller delivers Products to Buyer. Any communication construed as an offer by Seller and acceptance thereof is expressly limited to these Terms and Conditions. The Products are intended for industrial/commercial use by professional contractors and their trained employees and are not intended for use by consumers.

**2. Terms of Payments.** Payment for Products purchased by Buyer shall be made in accordance with any of the following terms, provided they have been previously arranged with and expressly approved by Seller in writing: (1) cash in advance; (2) confirmed, irrevocable letter of credit established in such amount and form and at such time and at such bank as shall be approved by Seller in respect of each order; (3) credit account purchases for which payment will be due and payable on net thirty (30) day terms, plus service and other charges applicable to past due amounts in accordance with Seller’s written notices; or (4) other payment arrangements expressly approved by Seller in writing prior to or at the time the order is placed. If any Buyer credit account purchase is not paid in accordance with Seller’s credit payment terms, in addition to any other remedies allowed in equity or by law, Seller may refuse to make further shipments without advance payment by Buyer. Nothing contained herein shall be construed as requiring Seller to sell any Products to Buyer on credit terms at any time, or prohibiting Seller from making any and all credit decisions which it, in its sole discretion, deems appropriate for Seller. Seller shall have the right, at its option, to charge interest on all amounts not paid when due and Buyer agrees to pay such interest calculated on a daily basis, from the date that payment was due until the Seller receives payment in full, at the rate of 1.5% per month or the maximum rate permitted by applicable law. Unless otherwise agreed in writing between Seller and Buyer, Seller may, in its sole discretion, increase or decrease the price of any Product, as Seller deems reasonably necessary, at any time prior to shipment and invoice Buyer for the same. If Buyer orders the chassis through Seller, the chassis payment is due upon receipt of chassis by Seller and the balance owed for the completed unit is due in accordance with agreed upon payment terms. When supplied by Buyer, Seller will inspect the chassis upon receipt and will notify Buyer of any chassis mounted components (including but not limited to fuel tanks, air tanks, battery boxes and exhaust systems) that require relocation. Buyer will be invoiced for such work upon completion of the finished Equipment.

**3. Taxes and Duties.** Unless otherwise noted, prices quoted do not include taxes or duties of any kind or nature. Buyer agrees that it will be responsible for filing all tax returns and paying applicable tax, duty, export preparation charge and export documentation charge resulting from the purchase of the Products. In addition, in the event any other similar tax is determined to apply to Buyer’s purchase of the Products from Seller, Buyer agrees to indemnify and hold Seller harmless from and against any and all such other similar taxes, duties and fees. All prices quoted are U.S. dollars unless otherwise specified. The amount of any present or future taxes applicable to the sale, transfer, lease or use of the Products shall be paid by Buyer; or in lieu thereof, Buyer shall provide Seller with a tax exemption certificate satisfactory to the applicable taxing authority proving that no such tax is due and payable upon such sale, transfer, lease or use.

**4. Title, Property, Risk and Delivery.** Unless otherwise stated in writing, for all intra-continental United States shipments, all prices and delivery are FCA, point of manufacture (Incoterms 2020); for all other shipments, all prices and delivery are FAS, named port of shipment (Incoterms 2020). Title and all risk of loss or damage to Products shall pass to Buyer upon delivery, as per Incoterms 2020. Any claims for loss, damage or delay in transit must be entered and prosecuted by the Buyer directly with the carrier, who is hereby declared to be the agent of the Buyer. Seller shall not be liable for any delay in performance of this agreement or delivery of the Products, or for any damages suffered by Buyer by reason of delay, when the delay is caused, directly or indirectly, by a force majeure event described in Section 20 herein or any other cause beyond Seller’s control. Claims for shortages in shipments shall be deemed waived and released by Buyer unless made in writing within five (5) days after Buyer’s receipt of shipment. Seller’s responsibility for shipment shall cease upon delivery of the Products to the place of shipment, and all claims occurring thereafter shall be made to or against the carrier by Buyer. Delivery shall generally be 240 to 270 days after receipt by Seller of a signed Order, provided that, where applicable: (1) Seller receives the chassis a minimum of 90 days prior to scheduled delivery, (2) drawings are timely sent by Buyer and the approved drawings are returned to Seller by Buyer by the requested date, (3) all vendor-supplied components and Buyer-supplied accessories are received by Seller by the date necessary to comply with scheduled delivery. Seller shall not be liable for any delay in performance of this agreement or delivery of the Products, or for any damages suffered by Buyer by reason of delay, when the delay is caused, directly or indirectly, by a force majeure event described in Section 20 herein or any other cause beyond

Seller's control. Claims for shortages in shipments shall be deemed waived and released by Buyer unless made in writing within fifteen (15) days after Buyer's receipt of shipment. Seller's responsibility for shipment shall cease upon delivery of the Parts and or Equipment to the place of shipment, and all claims occurring thereafter shall be made to or against the carrier by Buyer.

**5. Delays Caused By Buyer.** In the event of a delay in shipment or delivery due to delay by Buyer in furnishing delivery instructions, arranging a method of payment satisfactory to Seller, submitting valid import permits or licenses, or any other delay caused by Buyer or at Buyer's request, if the Products are not shipped or delivered within five (5) days from the first date they are ready to be shipped or delivered, then Seller shall be entitled to charge, as compensation, any additional costs incurred related to such delay. If the Products are not shipped or delivered by the date which is ten (10) days from the first date they are ready to be shipped or delivered, then Buyer's order shall be deemed cancelled and Seller may, in its sole discretion, sell such Products to another buyer without any liability or responsibility to Buyer whatsoever. Seller shall have the right to keep payments on account already received from Buyer, and the difference between the sales price (increased by any other and all further costs, including but not limited to attorney's fees and expenses, storage and other costs, and interest accrued thereon) and the price received from another buyer shall constitute a debt of Buyer and bear interest at the same rate set forth in Section 2 herein. Seller shall be entitled to claim for any further damages suffered as a consequence of Buyer's breach of its obligations hereunder.

**6. Cancellation.** Prior to delivery to place of shipment, a Product order may be cancelled only with Seller's prior consent and upon terms indemnifying Seller from all resulting losses and damages. Seller shall have the right to cancel and refuse to complete a Product order if any term and/or condition governing this agreement is not complied with by Buyer. In the event of cancellation by Seller, or in the event Seller consents to a request by Buyer to stop work or to cancel the whole or any part of any order, Buyer shall, in the event that Seller asks Buyer to do so, make reimbursement to Seller, as follows: (i) any and all work that can be completed within thirty (30) days from date of notification to stop work on account of cancellation shall be completed, shipped and paid in full; and (ii) for work in progress and any materials and supplies procured or for which definite commitments have been made by Seller in connection with the order, Buyer shall pay such sums as may be required to fully compensate Seller for actual costs incurred, plus fifteen percent (15%). Buyer may not cancel any order after Seller's delivery to place of shipment. Orders for "Special" Equipment may not be cancelled after acceptance, except by Seller. Items of "Special" Equipment are those that differ from standard Seller specifications, have a limited market, or incorporate specifications that have been determined for a specific application. Determination of whether an item of Equipment is "Special" shall be made by Seller in its sole discretion.

**7. Inspection and Acceptance.** Buyer agrees that it shall inspect the Products immediately after receipt and promptly (in no event later than fifteen (15) days after receipt) notify Seller in writing of any non-conformity or defect. Buyer further agrees that failure to give such prompt notice or the commercial use of the Products shall constitute acceptance. Acceptance shall be final and Buyer waives the right to revoke acceptance for any reason, whether or not known by Buyer at the time of such acceptance. The giving of any such notice by Buyer shall automatically cause the provisions of Seller's warranty to apply and govern the rights, obligations and liabilities of the parties with respect to such nonconformity or defect, provided under no circumstances shall rejection give rise to any liability of Seller for incidental or consequential damages or losses of any kind. Seller shall not be bound by any agent's, employee's or any other representation, promise or inducement not set forth herein. Seller's catalogues, technical circulars, price lists, illustrations, drawings and any other similar literature are for Buyer's general guidance only and the particulars contained in them shall not constitute representations by Seller and Seller shall not be bound by them.

**8. Warranty for New Products.** Seller warrants its new Equipment and Parts manufactured and sold worldwide, to be free, under normal use and service, of any defects in material or workmanship for a period of twelve (12) months from the date of delivery (as limited by Seller's Limited Product Warranty); provided that Buyer sends Seller written notice of the defect within thirty (30) days of its discovery and establishes that: (i) the Equipment has been operated and maintained in strict compliance with Seller's operating and maintenance manuals ; and (ii) the defect did not result in any manner from the intentional or negligent action or inaction of Buyer, its agents or employees and (2) a new machine registration certificate has been completed, signed and delivered to the Seller within thirty (30) days of the Equipment's "in-service" date. If requested by Seller, Buyer must return any defective Product to Seller's manufacturing facility, or other location designated by Seller, for inspection, and if Buyer cannot establish that conditions (i) and (ii) above have been met, then this warranty shall not cover the alleged defect. Failure to give written notice of defect within such period shall be a waiver of this warranty and any assistance rendered thereafter shall not extend or revive it. Accessories, assemblies and components included in the Products of Seller, which are not manufactured by Seller, are subject to the warranty of their respective manufacturers. This warranty shall not cover any item on which serial numbers have been altered, defaced or removed. Maintenance and wear parts are not covered by this warranty and are the sole maintenance responsibility of Buyer. This warranty is limited to the original purchaser or end-user if sold to a distributor, and is not assignable or otherwise transferable without written agreement of Seller. **THIS WARRANTY IS EXPRESSLY IN LIEU OF AND EXCLUDES ALL OTHER WARRANTIES, EXPRESS OR IMPLIED (INCLUDING THE WARRANTIES OF MERCHANTABILITY AND FITNESS FOR A PARTICULAR PURPOSE) AND ALL OTHER OBLIGATIONS OR LIABILITY ON SELLER'S PART. THERE ARE NO WARRANTIES THAT EXTEND BEYOND THE LIMITED WARRANTY CONTAINED HEREIN.** Seller neither assumes nor authorizes any other person to assume for Seller any other liability in connection with the sale of Seller's Products. This

warranty shall not apply to any of Seller's Products or any part thereof which has been subject to misuse, alteration, abuse, negligence, accident, acts of God or sabotage. No action by either party shall operate to extend or revive this limited warranty without prior written consent of Seller.

**9. Warranty for Used Equipment.** Used Equipment sold hereunder is sold on an "AS IS, WHERE IS, WITH ALL FAULTS" BASIS WITH NO WARRANTIES WHATSOEVER, EXCEPT AS TO TITLE, UNLESS OTHERWISE SPECIFICALLY AGREED IN WRITING BY BUYER AND SELLER. SELLER ASSUMES NO RESPONSIBILITY FOR THE CONDITION, SAFETY, LEGAL COMPLIANCE, OR USABILITY OF THE USED EQUIPMENT AND MAKES NO REPRESENTATION OR WARRANTY, EXPRESS OR IMPLIED, WITH RESPECT TO THE USED EQUIPMENT INCLUDING, WITHOUT LIMITATION, ANY IMPLIED WARRANTY OF MERCHANTABILITY OR FITNESS FOR A PARTICULAR PURPOSE. SELLER MAKES NO REPRESENTATION OR WARRANTY REGARDING THE CONDITION OF THE USED EQUIPMENT, NOR THE SUFFICIENCY OF ANY WARNINGS, INSTRUCTIONS OR MANUALS PROVIDED WITH THE USED EQUIPMENT. Seller recommends and Buyer acknowledges that Buyer should contact the original manufacturer to obtain all available information for the used Equipment, including but not limited to product manuals, warnings, safety bulletins, recall notices, and instructional placards before using the used Equipment. Seller shall not be responsible for providing such information. Buyer agrees not to assert any claims against Seller with respect to the used Equipment or its use. Buyer agrees that it shall inspect the used Equipment prior to issuance of a purchase order for such Equipment and acknowledges that it is not relying upon any photographs, images, videos, representations, statements or other assertions made by Seller with respect to the used Equipment's condition, but is relying upon its own knowledge and/or inspection of the used Equipment.

**10. Remedies for Breach.** IN THE EVENT OF ANY BREACH OF THE WARRANTY BY SELLER, THE PARTIES AGREE THAT SELLER'S LIABILITY SHALL BE LIMITED EXCLUSIVELY TO THE REMEDIES OF REPAIR OR REPLACEMENT (AT SELLER'S SOLE DISCRETION) OF ANY DEFECTIVE EQUIPMENT COVERED BY THE WARRANTY. In no event shall any repair or replacement of any defective equipment covered by the Seller's warranty extend the length of the warranty beyond the period specified in Section 8 herein.

**11. Limitation of Liability.** NOTWITHSTANDING ANYTHING CONTAINED IN THIS AGREEMENT TO THE CONTRARY, SELLER AND ITS AFFILIATES SHALL NOT BE LIABLE FOR, AND SPECIFICALLY DISCLAIM, ANY LIABILITY FOR ANY: (A) LOST PROFITS AND/OR BUSINESS INTERRUPTION (WHETHER DIRECT OR INDIRECT); AND (B) INDIRECT, INCIDENTAL, CONSEQUENTIAL (WHETHER DIRECT OR INDIRECT) OR OTHER DAMAGES OR LOSSES OF ANY KIND WHATSOEVER, including, without limitation, labor costs, lost profits, loss of use of other equipment, third party repairs, personal injury, emotional or mental distress, improper performance or work, penalties of any kind, loss of service of personnel, or failure of Products to comply with any federal, state, provincial or local laws, regardless of whether arising from a breach of contract, or warranty, legal claims or otherwise. **Nothing in this Section shall operate to exclude Seller's liability for death or personal injury when directly related to Seller's negligent act or omission.**

**12. Limitation of Actions.** Any action for breach of this agreement must be commenced within one (1) year after the cause of action has accrued.

**13. Specification Changes.** In the event Seller incurs additional expense because of changes in specifications or drawings previously approved by Buyer, or in the event Seller is required to modify the ordered Equipment, perform any additional work or supply any additional Products, the additional expense shall be added to the purchase price. Buyer must submit to Seller a revised purchase order specifying any and all requested changes. Upon receipt of Buyer's revised purchase order, Seller shall have the right, in its sole discretion, to accept or reject any changes in specifications requested by Buyer.

**14. Trade-in Offers.** Trade-in offers are subject to Seller's inspection and acceptance of the equipment, which must have been maintained to U.S. Department of Transportation operating and safety standards. All accessories on the equipment, including without limitation jibs, winches, pintle hooks and trailer connectors, must remain with the equipment unless otherwise agreed by Seller and Buyer in writing. Seller reserves the right to cancel any trade-in offers or agreements if these conditions are not met, or if Buyer has misrepresented any information about the trade-in unit.

**15. Insurance.** Until the purchase price of any Products is paid in full, the Buyer shall provide and maintain insurance equal to the total value of the Equipment delivered hereunder against customary casualties and risks; including, but not limited to fire and explosion, and shall also insure against liability for accidents and injuries to the public or to employees, in the names of Seller and Buyer as their interest may appear, and in an amount satisfactory to Seller. If the Buyer fails to provide such insurance, it then becomes the Buyer's responsibility to notify the Seller so that the Seller may provide same; and the cost thereof shall be added to the contract price. All loss resulting from the failure to affect such insurance shall be assumed by the Buyer.

**16. Patents, Copyrights, Trademarks, Confidentiality.** No license or other rights under any patents, copyrights or trademarks owned or controlled by Seller or under which Seller is licensed are granted to Buyer or implied by the sale of Products hereunder. Buyer shall not identify as genuine products of Seller products purchased hereunder which Buyer has treated, modified or altered in any way, nor shall Buyer use Seller's trademarks to identify such products; provided, however, that Buyer may identify such products as utilizing, containing or having been manufactured from genuine products

of Seller as treated, modified or altered by Buyer or Buyer's representative, upon prior written approval of Seller. All plans, photographs, designs, drawings, blueprints, manuals, specifications and other documents relating to the business of Seller ("Information") shall be and remain the exclusive property of Seller and shall be treated by Buyer as confidential information and not disclosed, given, loaned, exhibited, sold or transferred to any third party without Seller's prior written approval; provided, however, that these restrictions shall not apply to Information that Buyer can demonstrate: (a) at the time of disclosure, is generally known to the public other than as a result of a breach of this Agreement by Buyer; or (b) is already in Buyer's possession at the time of disclosure by from a third party having a right to impart such Information.

**17. Default and Seller's Remedies.** In the event of default by Buyer, all unpaid sums and installments owed to Seller, shall, at Seller's sole option, become immediately due and payable without notice of any kind to Buyer. In addition to its right of acceleration, Seller may pursue any and all remedies allowed by law or in equity, including but not limited to any and all remedies available to it under the Delaware Uniform Commercial Code. In addition to the foregoing, and not in limitation thereof, Seller shall have the right to set off any credits or amounts owed to Buyer against any amounts owed by Buyer to Seller.

**18. Indemnification by Buyer.** Buyer hereby agrees to indemnify, release, defend and hold harmless Seller, its directors, officers, employees, agents, representatives, successors, and assigns against any and all suits, actions or proceedings at law or in equity (including the costs, expenses and reasonable attorney's fees incurred in connection with the defense of any such matter) and from any and all claims demands, losses, judgments, damages, costs, expenses or liabilities, to any person whatsoever (including Buyer's and Seller's employees or any third party), or damage to any property (including Buyer's property) arising out of or in any way connected with the performance or the furnishing of Products under this agreement, regardless of whether any act, omission, negligence (including any act, omission or negligence, relating to the manufacture, design, repair, erection, service or installation of or warnings made or lack thereof with respect to any Products furnished hereunder) of Seller, its directors, officers, employees, agents, representatives, successors or assigns caused or contributed thereto. If Buyer fails to fulfill any of its obligations under this paragraph or this agreement, Buyer agrees to pay Seller all costs, expenses and attorney's fees incurred by Seller to establish or enforce Seller's rights. The provisions of this paragraph are in addition to any other rights or obligations set forth in this agreement.

**19. Installation.** Unless otherwise expressly agreed in writing, Buyer shall be solely responsible for the installation and erection of the Products purchased. Although Seller may in some cases provide a serviceman, data and drawings to aid Buyer with installation or start-up, Seller assumes no responsibility for proper installation or support of any Products when installed and disclaims any express or implied warranties with respect to such installation and support. Notwithstanding whether data and drawings are provided or a serviceman aids in the installation, Buyer shall indemnify and hold Seller harmless and at Seller's request, defend Seller from all claims, demands or legal proceedings (including the costs, expenses and reasonable attorney's fees incurred in connection with the defense of any such matter) which may be made or brought against Seller in connection with damage or personal injury arising out of said installation or start-up.

**20. Force Majeure.** Seller shall not be liable to Buyer or be deemed to be in breach of this agreement by reason of any delay in performing, or any failure to perform, any of Seller's obligations in relation to the Products if the delay or failure was due to any cause beyond the reasonable control of Seller including (without limitation) strike, lockout, riot, civil commotion, fire, accident, explosion, tempest, act of God, war, epidemic, stoppage of transport, terrorist activity, supply shortage or changes in government, governmental agency, laws, regulations or administrative practices.

**21. Anti-Corruption; Export Controls; No Boycotts.** Buyer agrees that it shall, and that any party retained or paid by the Buyer ("Retained Party") shall, comply with all applicable laws including, but not limited to, laws prohibiting public corruption and commercial bribery. Buyer further agrees that it shall, and that any Retained Party shall, comply with all applicable export controls, economic sanctions, embargoes and regulations regarding the export, re-export, shipment, distribution and/or sale of Products, technology, information or warranty related services. Buyer further agrees that it shall not, and any Retained Party shall not, export or re-export Products, technology, information or warranty related services directly or with its knowledge indirectly into Iran, Sudan, Cuba, Syria, North Korea, the Crimea Region of the Ukraine or Russia without Buyer first obtaining written approval from Seller. Failure to comply strictly with this section and all applicable laws, regulations and licensing/approval requirements shall be grounds for immediate termination of this agreement by Seller. Notwithstanding anything to the contrary contained in any agreement between the Buyer and Seller or in any other document or agreement relating to the Products sold hereunder, Seller will not comply with requests related to the boycott of any country or other jurisdiction, except to the extent such boycott is required by or otherwise not inconsistent with United States law.

**22. Telematics.** If a telematics system is included with the Equipment, the telematics system is administered by a third party ("Teleservice Provider") and collects a range of operational data about the Equipment including, but not limited to, usage, performance and reliability. Buyer consents to Seller's obtaining such data from the Teleservice Provider for warranty, product improvement, marketing and customer support purposes and to Seller's management and reporting of data (personal and non-personal) about the Equipment including, but not limited to, fuel consumption, up/down times, operation, defects, parts replacement, movement and location. Buyer shall, to the extent required by applicable law, obtain consent from its customers and/or any third party for Seller and/or third parties to provide teleservices and data to Buyer. Buyer shall

comply with all applicable laws relating to the provision of teleservices. Buyer agrees to be bound by the current version of the Terex Telematics Terms of Use at <https://www.terex.com/en/products/telematics-tou>.

**23. Construction and Severability.** These Terms and Conditions of Sale constitute the entire agreement between the parties regarding the subject matter hereof and shall be construed and enforced in accordance with the laws of Delaware. The United Nations Convention on Contracts for the International Sale of Goods (1980) (CISG) shall not apply. The invalidity or unenforceability of any provisions of this agreement shall not affect any other provision and this agreement shall be construed in all respects as if such invalid or unenforceable provision were omitted.

**24. Jurisdiction.** The parties agree that the proper and exclusive forum and venue in all legal actions brought to enforce or construe any provisions herein shall be in United States District Court, District of Delaware or, if federal jurisdiction is lacking in such action, in New Castle County Superior Court in Delaware.

**25. No Assignment.** No rights arising under this agreement may be assigned by the Buyer unless expressly agreed to in writing by the Seller.

**26. No Set-off.** Buyer shall have no right to set-off any amounts it may owe Seller against amounts Seller may owe Buyer under this or any other agreement between Buyer and Seller.

**27. Miscellaneous.** Buyer represents that: (i) it is solvent and has the financial ability to pay for the Equipment and Parts purchased hereunder and (ii) it has all requisite right, power and authority to perform its obligations under this agreement.

Buyer's Initials: \_\_\_\_\_



Terex Utilities, Inc.  
3140 15<sup>th</sup> Ave SE, Watertown, SD 57201  
Phone: 605-882-4000 Fax: 605-882-1842

09/03/2021

**CITY OF OXFORD**  
110 WEST CLARK STREET  
OXFORD, GA 30054  
Attention: JODY REID

Phone: (404)725-6519

**Qty. Description**

UNIT

- 1 One (1) new Terex Commander 4047 model hydraulic rotating digger derrick with a turntable winch.

**Design Criteria:**

- \* Design criteria is in accordance with current industry and engineering standards applicable and accepted for structural and hydraulic design.
- \* Meets ANSI/ASSE A10.31-2019.

**Elevation:**

- \* From +80 degrees above horizontal to -20 degrees below horizontal.

**Dual Lift Cylinders:**

- \* Double-acting cylinders with chrome plated rods and integral holding valves. Trapezoid mounting design offers greater boom support and stability providing less wear and longer life. Either cylinder can hold the rated lifting capacity of the derrick.

**Steel Lower Boom:**

- \* The boom is a fabricated box utilizing high-strength steel plates.

**Steel Intermediate Boom:**

- \* Fabricated box constructed of high strength steel. Powered by a double acting hydraulic cylinder equipped with integral holding valves on both extend and retract ports.

**Fiberglass Hydraulic Upper Boom:**

- \* Capable of lifting the hydraulic capacity of the derrick in all positions.
- \* Tested and rated for line voltage up to and including 46 KV AC.
- \* Tapered non-metallic rollers mounted at the end of the intermediate boom support the fiberglass boom under load minimizing scratches and abrasions. The sides of the fiberglass boom are supported and guided by non-metallic rollers to reduce tracking.

**Continuous And Unrestricted Rotation:**

- \* A hydraulic rotary manifold provides a rotating oil distribution system for continuous and unrestricted rotation.

**Miscellaneous:**

- \* Relief valves to protect the derrick circuits and digger-winch circuits.
- \* Hydraulic hoses are equipped with permanent type hose fittings.
- \* A custom load chart stating actual lifting capacity considering all final options, chassis, body,



**Qty. Description**

outriggers, and other fixed equipment with capacity based on completed unit stability is included.

- \* A boom-angle indicator and decal are mounted on each side of the lower boom.
- \* All metallic components of the complete digger derrick device are prime painted.
- \* Two complete manuals providing operational and maintenance procedures, and a replacement parts listing.
- \* Warning decals provided with unit.

Turntable Winch Including Transferrable Pole Buddy Assembly:

- \* 15,000 lb. bare drum capacity worm gear winch equipped with hydraulic counterbalance valve mounted on the derrick turntable. Equipped with flanged pole buddy transferrable from intermediate boom to upper boom.

Bare Boom Lift Capacities:

- \* Boom Angle: All Booms Retracted
- \* Maximum Elevation 24750 lbs.
- \* 10 Ft. Radius 11000 lbs.

Work Zone Capacities:

- Median Digging Radius 20.5 ft.
- Digging Capacity at Median Radius 2542 lbs.
- Lift Capacity at Median Radius 4524 lbs.

Sheave Height:

- \* With intermediate boom extended, 38.6 ft. at maximum elevation.
- \* With upper boom extended, 47.4 ft. at maximum elevation.
- \* Dimensions are based on a 40" chassis frame height.

Load Radius:

- \* 28.5 ft. from C/L of rotation, at 0 degree, intermediate boom extended.
- \* 37.5 ft. from C/L of rotation, at 0 degree, upper boom extended.

1 RH Command Post:

- \* Glycerin filled pressure gauge is provided to monitor system pressure.
- \* Permanent type control decals are provided.
- \* Adjustable cushioned operator seat is provided as standard and includes side rails.
- \* Hydraulic foot throttle.
- \* Includes a control and horn.
- \* Stop/start at control station.

1 Operator LED light at controls at command post/console.

1 Pole Guide For Transferable Pole Buddy with Interlock:

- \* Hydraulic cylinders equipped with holding valves operate the tilt and open/close on pole guide arms.
- \* Pole guide hoses are contained in a chain type carrier, installed on the side of the boom.
- \* Transfers from the end of the intermediate boom to the end of the upper boom and vice versa.
- \* The pole guide is installed on the transferable pole buddy flange assembly.
- \* Protects both the pole guide and the boom from accidental damage caused by extending the upper boom while the pole guide is on the intermediate boom and tilted downward. Includes actuating plunger and two poppet valves.

**Qty. Description**

- 1 Exclusive Single Stick T" Control:
  - \* Control allows one hand to operate three functions: rotation, boom elevation, and intermediate boom extension.
  - \* Upper boom extension and other functions have individual controls.
  
- 1 Pole Claw Arms:
  - \*Unique circular design of arms that handle poles up to 23 inch diameter.
  
- 1 Load Moment Limiter (Hydraulic Overload Protection) for Boom and Rotation systems:
  - \* An Operator aid to prevent damage to the derrick by stopping selected functions if an over load occurs. The functions necessary to eliminate the overload condition remain operational, to relieve the cause of overload.
  - \* Disables boom down, boom extend, winch up, and digger dig when boom lift or rotation senses an overloaded condition.
  - \* The system is fully automatic relative to the operation and re-set functions.

Pressure Gauge with Color Zone Ring for Load Moment Limiter:
  - \* A indicator gauge which provides an indicator when approaching maximum capacity.
  
- 1 Worm Gear Rotation:
  - \* Provided by worm gear drive through reversible hydraulic motor. Worm gear drive powers a special design long life hardened "shear ball" ball bearing rotation gear.
  
- 1 Customer Declined, Anti-Two Block.
  - \* Purchaser is aware of OSHA Crane and Derrick standard, subpart CC for construction (1926.1416).
  
- 1 12,000 ft-lb Two Speed Digger With Hydraulic Shift (ESK 76BA):
  - \* Planetary gear drive powered by reversible hydraulic motor.
  - \* Telescopic trombone tube is provided to shift the two-speed digger hydraulically.
  
- 1 LH Auger Storage and Digger Hanger:
  - \* Digger hanger bracket is box section and is equipped with a transfer protection system, auger stowage bracket with self latching auger catch and hydraulic auger release.
  - \* The auger stowage bracket stores up to a 24" diameter auger, in the standard position.
  - \* Digger storage protection system to protect the auger storage cable from damage caused by over-winding. Oil from the digger system is returned to tank before the cable is over-stressed.
  
- 1 Wire rope cable for auger roll-up.
  
- 1 Solid Hex Auger Shaft with Coupler:
  - \* 60" long x 2-5/8" hex auger shaft with auger adjustment holes.
  
- 1 Terex Texoma 18" TXD (dirt tooth auger) x 104" long - 60" of 5/16" flighting, 2 5/8" hex bushing. Rollup dish and cable pin welded in place and auger painted Terex Red.
  
- 1 Pedestal:
  - \* Square constructed pedestal has access holes for maintenance of hydraulic plumbing.
  
- 1 Pump For Use (Required Approximate 120% PTO):
  - Tandem vane high efficiency 3000 psi rated hydraulic pump providing 40 gallons per minute combined flow.

**Qty. Description**

\* Provides 16 gallons per minute to boom functions and 24 gallons per minute to digger/winch functions and combines flow when boom is not in operation providing 40 gallons per minute to digger/winch at 1600 rpm engine speed, boom extension is faster than winch.

\* Provides up to 6 gallons per minute for tools at 700 rpm engine speed.

\*Includes pump kit.

FOR GENERAL ONLY: With the use of Radio Controls.

1 Hydraulic Reservoir:

50 gallon hydraulic oil reservoir includes 10 micron replaceable cartridge type return line filter mounted in reservoir with bypass valve incorporated in filter to prevent restricted flow.

\* A 100 mesh in screen in filter cap. A 40 mesh screen included in tank outlet and a 2 1/2" full flow ball type shut off valve.

\* Relief valves to protect the derrick circuits and digger-winch circuits.

1 Extra Heavy Duty A-Frame Outriggers with swivel type stabilizer pads. (8348)

1 Heavy Duty A-Frame Outriggers with swivel type stabilizer pads. (9283)

1 Controls For 2-Sets Of Outriggers And Auxiliary Tool Outlets Below Rotation (Diggers):

\* Recessed at rear of truck each side for ease of view for outrigger placement.

\* Includes switches and alarm for outrigger in motion alarm.

1 High Pressure code to obtain 3000 psi at outriggers.

Note - this is on A-frames and Radial outriggers for Digger Derricks.

1 Adjustable flow divider for auxiliary tool outlets below rotation.

1 Outrigger Interlock:

\* To operate the boom the outriggers must be extended.

1 Subframe constructed with an open center.

1 Tie Down Kit.

1 Remote Sensor Bracket:

\* Bracket to be used with the Williams remote sensor. Installed to supply sensor to work with truck engine.

1 Terex Advanced Chassis Controller:

\* Multiplexed system to include: Controller, LCD Screen, Manual and Schematics.

\* Standard Options: Diagnostics, Status Screens, Event Log, Hours Meter, Selectable Button Labels, System Alerts and System Test.

\* Programmable settings allow installer to customize/select options need for their application.

\* Back-up Camera ready.

\* Screw terminal-type connections and enclosure to cover connections.

\* Recommended on Class 6 and above chassis with multiple outputs

\* The PTO hour is standard. The engine hour meter is standard (When available). This is a message we get from the truck Data link. All trucks except Ford give us the Engine hours. So if it's a Ford, we just display PTO hours.

1 American flag displayed on unit.

**Qty. Description**

- 1 Factory Warranty
- 1 Clevis for two part line attachment.
- \*\* ALTERED FROM STANDARD \*\*
- 1 .
  
- BODY, INSTALLATION
- \*\* BODY INFORMATION \*\*
- 1 144 Inch Flatbed with T-40 per the attached specifications.
  
- 1 Install Derrick Over Rear Axle And Install All Associated Components:  
\* Final test and inspect completed unit including stability and dielectric testing per manufacturers requirements.
- 1 Hose and fittings to connect the hydraulic system from the oil reservoir to the pump and unit.
- 1 Power take off with indicator light for automatic transmission.
- 1 DOT Inspection.
- 1 Set chassis parameters.
- 1 Back-up alarm to sound when the vehicle is shifted into reverse.
- 4 Laminated wood outrigger pad 24" x 24" x 2-1/4" with rope handle.  
\* Includes outrigger pad storage.
- 4 Rubber wheel chocks with eye bolt.
- 1 Grab handles as necessary for 3-point contact.
- 1 Fixed access step mounted on command post.
- 2 Mud flap with logo 30" tall.  
Note: Trim As-Required.
- 1 A mounting kit for under 45" flatbed frame height for a pair of mud flaps.
- 1 Bracket for storing grounding cable.
- 1 2/0 Black Electrical Cable used for grounding per ASTM F855-04:  
\* 50' of multi-strand flexible copper cable, three grounding lugs, two ferrules and grounding clamp.  
\* Three point grounding system for grounding vehicle during work operations.  
\* Cable must be fully removed from bracket before use.  
NOTE! Purchaser to verify this meets their company's requirements for fault current.

**Qty. Description**

- 1 Grounding Loop Kit:
  - \* Consists of (2) grounding copper rings located one at front and one at rear.
- 1 Boom rest.
- 1 Digger Derrick single position boom rest saddle.
- 1 Peterson LED 7-lamp DOT Lighting Package:
  - \* Complies with FMVSS 108.
  - \* Includes required lights, junction box and wiring harness.
- 1 Lighted license plate bracket kit with LED light.
- 2 Amber strobe light (LED) with 4" tall & 6" dia. lens, and branch guard.
- 2 Strobe mounting bracket.
- 1 Glad Hand Kit
  - \*Requires tractor protection valve and air lines to the rear.
- 1 Remote engine stop/start And two speed control from rear of vehicle.
- 1 15 ton pintle hook:
  - \* Safety chain eyes.
  - "Pintle hook brackets and attachment methods are designed to meet the associated pintle hook ratings. They are not designed for recovery purposes. If recovery attachments are required, please order the appropriate tow eyes."
- 1 ICC rear bumper.
- 1 7-prong trailer socket.
  - NOTE: Stop & turn signal lights on combined circuit.
- 1 Oil tank mounting for external reservoirs.
- 60 Fill with Hydraulic oil for general purpose use.
  - \* Refer to the product maintenance manual for specific type to be used.
- 1 1 1/8" x 100' Samson, 2-IN-1 Stable Braid uncoated rope.
- 1 Crosby, Hook and Jam, Swivel, 8.5 ton w/Latch Assy.
- 1 Hannay spring loaded hydraulic hose reel with 4-way roller assembly with 50' of 1/2" Hose Set.
  - \* Quick disconnect HTMA male and female flush faced couplers and dust covers.
  - \* Installed on hose reel with ball stop.
- 1 Safety Kit consists of the following:
  - \* 5-lb ABC fire extinguisher with bracket.
  - \* James King triangle reflector kit.

**Qty. Description**

- 1 Paint C4000 derrick one color.
- 1 Paint body floor with non-skid paint.
- 1 Paint compartment top with non-skid paint.

**CHASSIS**

- 1 Freightliner M2 106 4x2 (Spec # 80)
  - \* 33,000 lbs GVWR
  - \* Wheelbase 189", CA 123", axle to frame 100"
  - \* 13,220-lb capacity front axle
  - \* 21,000-lb capacity locking rear axle
  - \* Cummins B6.7 (6.7L) 300 HP @ 2,600 rpm, torque 660 lb-ft @ 1,600 rpm
  - \* Allison 3500 RDS wide ratio, 5-speed automatic transmission with double overdrive
  - \* L0006EY White Elite EY

**SPECIAL CHARGES**

- 1 Delivery to Customer.

OPTIONS:

ADD



1. Federal Excise Tax will be added if certificate is not supplied with order.
2. The following items must be considered by the purchaser if not already included:  
Back-up Alarm \$150.00; Strobe Light \$525.00; Wheel Chocks \$110.00;  
Outrigger Pads \$200.00 to \$650.00 (based on pad size & type); Truck Grounding Cable \$550.00;  
Barricade Kit \$895.00; Hydraulic Over Load Protection (derrick only, price will vary  
based on final option selection); Boom / Boom Stow Interlock \$700.00; Engine Stop / Start  
\$200.00 to \$795.00 (based on unit model); Auxiliary Let Down \$1500.00; and Platform  
Liner \$380.00 to \$625.00 (based on platform size).
3. Terex Utilities, Inc. strongly recommends all installation accessories be located up front in  
front in the quote or secondarily on the approved engineering drawing. Any accessories located  
or relocated during manufacturing may be subject to additional charges.
4. Terex Utilities, Inc. - Offers In-service Training.
5. Terex Utilities, Inc. - Assembly in Watertown, South Dakota is ISO 9001:2000 Certified.

**Quotation Number**

**12813**

For the attention of	<b>Kyle Crom</b>	Name	<b>Chad Noeldner</b>
		Telephone	<b>(605) 884-1023</b>
<b>Customer:</b>	<b>Terex City of Oxford</b>	Date	<b>9/2/2021</b>

**DESCRIPTION**

**B&G Bodies Inc. T-40-02 Line Body 48 inches high X 94 inches wide.**

16 Ga. Galvanneal body materials.  
12 Ga. Hot rolled treadplate compartment tops.  
24 Inch compartment depth.  
Slam action paddle type door latches.  
Stainless steel rod and socket type door hinges.  
Chain stops on all doors.  
Double Panel Body Doors.  
Automotive Bulb Type Weatherstripping.  
Top rail package installed on top of transverse compartment. (3-Sides)

**B&G Bodies Inc. 144" Treadplate Flatbed 94 inches wide.**

12 Ga. Hot rolled treadplate floor.  
6" structural steel I-Beam crossmembers on 12" centers.  
Valve mounting plates on SS & CS of flatbed.  
4" High steel flat perimeter retainer, corners notched, welded to flatbed.  
7-Lamp light bar installed at rear.

**Streetside Compartmentation:**

**1st Vertical:**

40 Inches wide with Four (4) fixed material hooks 2-0-2.  
Barn type compartment doors.

**Curbside Compartmentation:**

**1st Vertical:**

40 Inch wide transverse compartment with a 66" tool board and track in Front portion.  
Front of board has Five (5) material hooks, rear has a full length tray, oak bit holder and peg hook.  
Three (3) material drawers each with adjustable dividers on 6 inch centers in rear portion.  
\* Top drawer is 4" high and lower 2 drawers are 6" high  
Transverse drawers each include a latch and are mounted on Roller Bearing Slides.  
One fixed through shelf on top of drawer set.  
Barn type compartment doors.

**2nd Vertical:**

24 Inch wide gripstrut access steps to bed area.  
1/4" Lasered flat installed under side access for mounting step.

**Subframe Installation:**

Install customer supplied subframe, with Standard outriggers.

Subframe is to be Bolted to Body - Do Not Weld to Sub Frame

- \* Subframe and Standard O/R's will be wet painted Black
- \* Grounding Bracket to be welded to Subframe at rear of truck and body
- \* Provide "Bolt In" style Filler Plate between Rear Jacks
- \* Hose Tunnel Pass Through cutout needed

**Stringer style body mounting includes the following:**

B&G Bodies to Provide lower and upper boom rest sections

Lower Section to be welded to Front Jack Assembly

Upper Section to be test fit into lower Section prior to shipment.

B&G Bodies to Provide box bolts to Terex with body to secure upper Section to lower section.

Terex to match drill upper Section holes.

Welding on B&G supplied body Mounting Angles

**Wheel Chock Storage:**

Four (4) Each under body V-type.

- \* Bolt-on Style

**Outrigger Pad Storage: (Bolt-On / Ship Loose)**

Two (2) Double outrigger pad storage brackets - 25" ID x 26" Deep x 9" High overall.

- \* Pendulum Retainers.

**Cable Step: (Bolt-On / Ship Loose)**

Two (2) Terex PN65338332 Cable type access step under tailshelf - One each side.

- \* Bolt-on Style

**Rigid Stirrup Step: (Bolt-On / Ship Loose)**

One (1) Rigid type perf-grip stirrup step for installing at side access.

**Tailgate:**

Removable Composite wood sidegate 5.5" high X full width of step area.

- \* Includes Pins and Lanyards

**Grab Handles:**

One (1) - 11" Bolt-On Type for installing at side access of body.

Five (5) Terex PN615161 Bolt-on grabhandles for installing on flatbed.

- \* One (1) at side access.
- \* Four (4) at rear - Two (2) each side.

**Paint:**

Finish Paint Body and Inside of compartments Taffeta White.

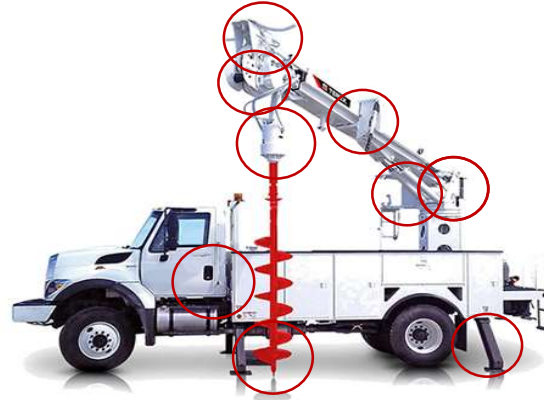

## Fleet Maintenance and Inspection Agreements

Contact us NOW for pricing! 1-210-476-7768

- We cater to your needs through pay-as-you-go, customized service agreements.
- We can cover your entire fleet, for all manufacturers!
- Our inspections provide a trusted and certified review of your unit.
- Maintain your Terex Limited Lifetime Structural Warranty eligibility by utilizing Terex Services for your maintenance needs!

Annual Inspection (4 Options)	Basic	Silver	Gold	Platinum
+ Dielectric Test	✓	✓	✓	✓
+ Lubrication & Filters		✓	✓	✓
+ Rotation Bolt Torque Checks*			✓	✓

180-Day Inspection (3 Options)	Basic	Silver	Gold
+ Lubrication & Filters	✓	✓	✓
+ Rotation Bolt Torque Checks*		✓	✓

90-Day Inspection (2 Options)	Basic	Silver
+ Lubrication & Filters*	✓	✓

We come to you!



Or you can come to us!



Get preferential travel rates by including your entire fleet!

•• Be sure to select your preferred inspection level to be quoted.

# TEREX SERVICE CENTERS KEEP YOUR EQUIPMENT WORKING



\*Terex recommends selecting to comply with ANSI/OSHA requirements.

# Preventive Maintenance and Inspection Program



C4047

Commander - Telescoping Material Handling Digger Derrick

5  
1

= number of years of preventive maintenance service in the quote  
= quantity of units to include in the quote

Include field service travel time (otherwise units will be serviced at a branch)

Please indicate customer location: East of Colorado Mountains

## Preventive Maintenance Packages, Single Unit

Basic	Silver	Gold	Platinum	Custom
<p>- Yearly visual inspection and operational test of all critical components.*</p> <p><i>* NOTE- Basic package by itself does not qualify as the required annual inspection under the Terex Limited Product Warranty</i></p>	<p>- Yearly visual inspection and operational test of all critical components.</p> <p>- Annual preventive maintenance as defined in maintenance manual, including the following:</p> <ul style="list-style-type: none"> <li>- Torque checking of rotation bolts, drift test, lubrication, hydraulic oil test, dielectric test</li> <li>- Replacement hydraulic oil filters and lubricant</li> <li>- Qualifies as the required annual inspection under the Terex Limited Product Warranty</li> </ul>	<p>- Yearly visual inspection and operational test of all critical components.</p> <p>- Annual preventive maintenance as defined in maintenance manual, including the following:</p> <ul style="list-style-type: none"> <li>- Torque checking of rotation bolts, drift test, lubrication, hydraulic oil test, dielectric test</li> <li>- Replacement hydraulic oil filters and lubricant</li> <li>- Qualifies as the required annual inspection under the Terex Limited Product Warranty</li> </ul> <p>- 90 day, 180 day, and 270 day inspection and preventive maintenance</p> <ul style="list-style-type: none"> <li>- Replacement hydraulic oil filters and lubricant</li> </ul>	<p>- Yearly visual inspection and operational test of all critical components.</p> <p>- Annual preventive maintenance as defined in maintenance manual, including the following:</p> <ul style="list-style-type: none"> <li>- Torque checking of rotation bolts, drift test, lubrication, hydraulic oil test, dielectric test</li> <li>- Replacement hydraulic oil filters and lubricant</li> <li>- Qualifies as the required annual inspection under the Terex Limited Product Warranty</li> </ul> <p>- 90 day, 180 day, and 270 day inspection and preventive maintenance</p> <ul style="list-style-type: none"> <li>- Replacement hydraulic oil filters and lubricant</li> </ul> <p>- 5 years preventive maintenance</p> <ul style="list-style-type: none"> <li>- Removal and inspection of leveling chains and insulator rods**</li> </ul> <p><i>** Not required for XT PROs, OPTIMAS, units equipped with Extended Life leveling chains, or units not equipped with leveling chains.</i></p>	<p>Package includes:</p> <p>See custom package configurator</p>
<p>Standard service price: \$4,800</p> <p>Your package price: \$4,156</p>	<p>Standard service price: \$6,576</p> <p>Your package price: \$5,694</p>	<p>Standard service price: \$18,076</p> <p>Your package price: \$15,652</p>	<p>Standard service price: \$18,076</p> <p>Your package price: \$15,652</p>	<p>Standard service price: \$11,226</p> <p>Your package price: \$9,720</p>
<p>You save: \$644</p>	<p>You save: \$882</p>	<p>You save: \$2,424</p>	<p>You save: \$2,424</p>	<p>You save: \$1,505</p>

Select your package:  Basic (customer declines, among others, torque check of critical fasteners)  
 Silver  Gold  Platinum  Custom

Customer confirms selection of the maintenance package indicated for the price and duration specified. Customer accepts and agrees to the attached Terex Terms and Conditions of Sale, which govern this transaction. In the event of early cancellation of this Agreement, Customer agrees that Terex shall be entitled to retain as liquidated damages, and not as a penalty, any fees paid in advance, which the parties agree reasonably approximate Terex's actual damages.

Customer signature: \_\_\_\_\_

## Preventive Maintenance and Inspection Program

### Custom Package Configurator

Product Code:

Commander - Telescoping Material Handling Digger Derrick



= number of years of service

= quantity of units to include in the quote

**Include the following periodic Preventive Maintenance:**

- 90 Days (360 Hours)
- 180 Days (720 Hours)
- 270 Days (1,080 Hours)
- 12 Months (1,050 Hours)
- Dielectric Test (Yearly)
- 5 Years (5,250 Hours)

**Include field service travel time**

Please indicate customer location:

#### Custom

Standard service price:  
\$11,226  
Your package price:  
**\$9,720**

**You save: \$1,505**

Visit us at [TEREX.com](http://TEREX.com)



## **PREVENTIVE MAINTENANCE AND INSPECTION PROGRAM**

### **A**      **SCOPE OF SERVICES**

- 1 For each Terex Utilities equipment unit specified in section C below, Service Provider will provide, annually, for the Basic Package: Visual inspections and operational tests; for the Silver Package: Annual preventive maintenance, dielectric test, lubricant and hydraulic filter; for the Gold Package: 90-Day preventive maintenance (except for XT PRO), 180-Day preventive maintenance, 270-Day preventive maintenance (except for XT PRO), Annual preventive maintenance, dielectric test; for the Platinum Package: 90-Day preventive maintenance (except for XT PRO), 180-Day preventive maintenance, 270-Day preventive maintenance (except for XT PRO), Annual preventive maintenance, dielectric test, 5 years preventive maintenance ; for the Custom Package: 180-Day preventive maintenance, Annual preventive maintenance, dielectric test, lubricant and hydraulic filter, ; services will be provided for 5 years, provided this Agreement has not expired or been terminated. Such Maintenance will be consistent with the applicable service manual for each Equipment unit. The commencement date for such Maintenance for the Equipment will be the on the equipment delivery date. Service Provider will have no obligation to perform Maintenance on any Equipment after termination or expiration of this Agreement.
  
- 2 The Maintenance will be conducted at the Designated Service Location specified in section C below. Maintenance outside such location will be performed at an additional fee to be agreed by the parties in advance. Customer shall provide a safe work area for the Maintenance, with electric power, water, waste disposal, and access provisions. Vehicle must be provided free and clear of debris to allow technician safe access to the equipment controls and pedestal area. Service Provider will provide periodic reports to Customer of the Maintenance that has been performed.
  
- 3 Maintenance and Inspection of the Equipment will be scheduled by Customer at least five (5) business days in advance. The parties will cooperate to ensure advance notice is provided to Service Provider of any additional service that may be requested.
  
- 4 In the event an Equipment unit does not meet the Inspection criteria because of needed repairs (“Repairs”), Service Provider will provide an estimated cost for such Repairs. Repairs will be performed upon Customer’s approval and issuance of a purchase order. The Repairs must be performed prior to Service Provider acknowledging that the Inspection is completed.
  
- 5 Maintenance, Inspections, and Repairs will be performed by Service Provider on the Equipment within the hours of 7:00 a.m. to 5:00 p.m. on normal business days (excluding weekends and public holidays). In the event Customer schedules Maintenance, Inspections, and/or Repairs outside of such hours, or on weekends or public holidays, the following additional fees will be charged: \$120.00 an hour, or for prorated portions of an hour depending on the time of completion. Fees will be billed from the time the Service Provider reaches the jobsite.
  
- 6 In the event Customer proposes changes to the Scope of Services stated herein, Service Provider reserves the right to renegotiate the fee agreed between the parties.

### **B**      **FEE SCHEDULE**

For the Basic Package: \$4,156; for the Silver Package: \$5,694; for the Gold Package: \$15,652; for the Platinum Package: \$15,652; for the Custom Package: \$9,720; for 5 years of service, with payment by Customer to Service Provider due upon signing of this Agreement.

### **C**      **LIST OF EQUIPMENT UNITS TO BE INSPECTED AND MAINTAINED**

The following equipment, listed by Serial Number and Model, is included under this Agreement:

Equipment Model: C4047

Equipment Serial Number(s):

This document will be supplemented with serial numbers for the units once they are available

Designated Service Location:

CUSTOMER'S ADDRESS

## ("Seller")

### TERMS AND CONDITIONS OF SALE

**1. Terms and Conditions.** The provision by Seller to Buyer of any Equipment or Parts (collectively referred to as "Products") and field labor, reconditioning, repair, maintenance and inspection services (collectively referred to herein as "Services") shall be exclusively governed by these Terms and Conditions of Sale ("Terms and Conditions") and Seller's sales order (collectively referred to as "Agreement"). This Agreement cancels and supersedes any and all terms and conditions previously issued by Seller and shall remain in effect unless and until superseded in writing by Seller. Acceptance of an order for Products or Services by Seller shall be deemed to constitute a binding agreement between the parties pursuant to these Terms and Conditions and Buyer agrees that the order may not thereafter be countermanded or otherwise changed without the explicit prior written consent of Seller. No other terms and conditions shall apply, including the terms of any purchase order submitted to Seller by Buyer, whether or not objected to by Seller or whether or not such terms are inconsistent or conflict with or are in addition to these Terms and Conditions. These Terms and Conditions shall be deemed accepted by Buyer if any of the following occurs: (i) if confirmed by Buyer, (ii) if undisputed by Buyer within ten (10) days after receipt, or (iii) if Seller delivers Products or Services to Buyer. Any communication construed as an offer by Seller and acceptance thereof is expressly limited to these Terms and Conditions. The Products are intended for industrial/commercial use by professional contractors and their trained employees and are not intended for use by consumers.

**2. Terms of Payments.** Payment for Products or Services purchased by Buyer shall be made in accordance with any of the following terms, provided they have been previously arranged with and expressly approved by Seller in writing: (1) cash in advance; (2) confirmed, irrevocable letter of credit established in such amount and form and at such time and at such bank as shall be approved by Seller in respect of each order; (3) credit account purchases for which payment will be due and payable on net thirty (30) day terms, plus service and other charges applicable to past due amounts in accordance with Seller's written notices; or (4) other payment arrangements expressly approved by Seller in writing prior to or at the time the order is placed. If any Buyer credit account purchase is not paid in accordance with Seller's credit payment terms, in addition to any other remedies allowed in equity or by law, Seller may refuse to make further shipments without advance payment by Buyer. Nothing contained herein shall be construed as requiring Seller to sell any Products or Services to Buyer on credit terms at any time, or prohibiting Seller from making any and all credit decisions which it, in its sole discretion, deems appropriate for Seller. Seller may charge interest on all amounts not paid when due and Buyer agrees to pay such interest calculated on a daily basis, from the date that payment was due until the Seller receives payment in full, at the rate of 1.5% per month or the maximum rate permitted by applicable law. Seller shall be entitled to an equitable adjustment in the price of Products or Services in order to account for increases in the cost to Seller of labor or materials, or in the event of unanticipated or unforeseen circumstances.

**3. Taxes and Duties.** Unless otherwise specified, prices quoted do not include taxes or duties of any kind or nature. Buyer agrees that it will be responsible for filing all tax returns and paying applicable tax, duty, export preparation charge and export documentation charge resulting from the purchase of any Products or Services. In addition, in the event any other similar tax is determined to apply to Buyer's purchase of any Products or Services from Seller, Buyer agrees to indemnify and hold Seller harmless from and against any and all such other similar taxes, duties and fees. All prices quoted are U.S. DOLLARS unless otherwise specified. The amount of any present or future taxes applicable to the sale, transfer, lease or use of any Products shall be paid by Buyer; or in lieu thereof, Buyer shall provide Seller with a tax exemption certificate satisfactory to the applicable taxing authority proving that no such tax is due and payable upon such sale, transfer, lease or use.

**4. Title, Risk, Transportation and Delivery.** Unless otherwise stated in writing, all prices and delivery are FCA, Seller's Premises (Incoterms 2010). Title and all risk of loss or damage to Products shall pass to Buyer upon delivery, as per Incoterms 2010. Any claims for loss, damage or delay in transit must be entered and prosecuted by the Buyer directly with the carrier, who is hereby declared to be the agent of the Buyer. In the event delay in shipment of Products is caused by Buyer's failure to furnish necessary information with respect to data and details for Buyer's specifications, Seller, may, in its sole discretion, extend the date of shipment for a reasonable time. In the event delay in shipment is caused by Buyer or at Buyer's request, and there are Products that are not shipped within ten (10) days from the first date they are ready to be shipped, Seller may, in its sole discretion, sell such Products to another buyer without any liability or responsibility to Buyer whatsoever. All payments shall be made in accordance with the terms of the applicable invoice. In addition, storage charges due to delay in furnishing delivery instructions, arranging and establishing a method of payment satisfactory to Seller, or submitting valid import permits or licenses, or any other delay caused by Buyer or at Buyer's request, will be for the account of Buyer. **SELLER SHALL NOT BE LIABLE FOR ANY LOSS OF USE OR FOR ANY OTHER INDIRECT, CONSEQUENTIAL, INCIDENTAL OR OTHER DAMAGES OR LOSSES DUE TO DELAY IN SCHEDULED DELIVERY.** Claims for shortages in shipments shall be deemed waived and released by Buyer unless made in writing within five (5) days after Buyer's receipt of shipment. Seller's responsibility for shipment shall cease upon delivery of the Products to the place of shipment, and all claims occurring thereafter shall be made to or against the carrier by Buyer.

**5. Cancellation.** Prior to delivery to place of shipment, a Products order may be cancelled only with Seller's prior written consent and upon terms indemnifying Seller from all resulting losses and damages. Seller shall have the right to cancel and refuse to complete a Products or Services order if any term and/or condition governing this agreement is not complied with by Buyer. In the event of cancellation by Seller, or in the event Seller consents to a request by Buyer to stop work or to cancel the whole or any part of any order, Buyer shall make reimbursement to Seller, as follows: (i) any and all work that can be completed within (30) days from date of notification to stop work on account of cancellation shall be completed, shipped and paid in full; and (ii) for work in progress and any materials and supplies procured or for which definite commitments have been made by Seller in connection with the order, Buyer shall pay such sums as may be required to fully compensate Seller for actual costs incurred, plus fifteen percent (15%). Buyer may not cancel any order after Seller's delivery to place of shipment. Orders for "Special" Equipment may not be cancelled after acceptance, except by Seller. Items of "Special" Equipment are those that differ from standard Seller specifications, have a limited market, or incorporate specifications that have been determined for a specific application. Determination of whether an item of Equipment is "Special" shall be made by Seller in its sole discretion.

**6. Inspection and Acceptance.** Buyer agrees that it shall inspect the Products or Services immediately after receipt of Products or completion of Services and promptly notify Seller in writing of any non-conformity or defect within 10 days after the Products are put into service or the Services are completed, but not more than thirty (30) days after delivery or completion. Buyer further agrees that confirmation that the Products or Services comply with the order, its commercial use of the Products or its failure to give prompt notice of non-conformity or defect shall constitute acceptance. Acceptance shall be final and Buyer waives the right to revoke acceptance for any reason, whether or not known by Buyer at the time of such acceptance. Acceptance shall automatically cause the provisions of Seller's warranty to apply and govern the rights, obligations and liabilities of the parties with respect to such nonconformity or defect, provided under no circumstances shall rejection give rise to any liability of Seller for incidental or consequential damages or losses of any kind.

## **7. Warranty for Products and Services.**

### **(a) For Equipment:**

Seller warrants its new Equipment manufactured and sold worldwide to be free, under normal use and service, from defects in material or workmanship for the time period designated in the warranty applicable to the particular type, make and model of Equipment or, in the event no specific warranty exists for such Equipment, for a period of twelve (12) months from the date of delivery.

### **(b) For Parts:**

- (i) Seller warrants that Parts supplied by Seller will be free, under normal use and service, from defects in material or workmanship for a period of twelve (12) months from the date of delivery, where Seller is the OEM of such Parts;
- (ii) Seller warrants that that Parts supplied in connection with a warranty repair on Equipment sold by Seller will be free, under normal use and service, from defects in material or workmanship for a period of time equal to the OEM warranty provided by the manufacturer of such Parts, but if there is no OEM warranty on such Parts, then such warranty period shall terminate upon the expiration of the warranty for the Equipment originally sold by Seller; and
- (iii) Seller warrants that Parts supplied in connection with Services performed by Seller on equipment not originally sold by Seller will be free, under normal use and service, from defects in material or workmanship for a period of time equal to the OEM warranty provided by the manufacturer of such Parts.

### **(c) For Services:**

- (i) Seller warrants that its field and shop labor services will be free from defects in workmanship for a period of ninety (90) days from the date of completion of such services;
- (ii) Seller warrants that its labor supplied in connection with its reconditioning services on mobile equipment will be free from defects in workmanship for a period of six (6) months from the date of completion of such services; and
- (iii) Seller provides no warranty, express or implied, on its inspection services.

The foregoing warranties shall only be valid if Buyer sends Seller written notice of the defect within thirty (30) days of its discovery and establishes that: (i) the Equipment or Parts, or any equipment subject to any Service, has been maintained and operated within the limits of rated and normal usage; and (ii) the defect did not result in any manner from the intentional or negligent action or inaction by Buyer, its agents or employees. If requested by Seller, Buyer must return the defective Equipment or Parts to Seller's facility for inspection, and if Buyer cannot establish that conditions (i) and (ii) above have been met, then the foregoing warranties shall not cover the alleged defect. Failure to give written notice of defect within such period shall be a waiver of the foregoing warranties and any assistance rendered thereafter shall not extend or revive it. Equipment, accessories, assemblies, components and Parts which are not manufactured by Seller are subject to the warranty of their respective manufacturers. The foregoing warranties shall be void in the event Buyer has carried out modifications or reconditioning work on the Equipment or Parts without the prior written consent of Seller. The foregoing warranties shall not cover any item on which serial numbers have been altered, defaced or removed. Maintenance and wear parts are not covered by the foregoing warranties and are the sole maintenance responsibility of Buyer. The foregoing warranties are limited to the first retail purchaser and are not assignable or otherwise transferable without the written agreement of Seller. **THE FOREGOING WARRANTIES ARE EXPRESSLY IN LIEU OF AND EXCLUDE ALL OTHER WARRANTIES, EXPRESS OR IMPLIED (INCLUDING THE WARRANTIES OF MERCHANTABILITY AND FITNESS FOR A PARTICULAR PURPOSE) AND ALL OTHER OBLIGATIONS OR LIABILITY ON SELLER'S PART. THERE ARE NO WARRANTIES THAT EXTEND BEYOND THE LIMITED WARRANTIES CONTAINED HEREIN.** Seller neither assumes nor authorizes any other person to assume for Seller any other liability in connection with the sale of Seller's Equipment, Parts or Services. The foregoing warranties shall not apply to any Equipment or Parts or any part thereof purchased from Seller, or any equipment which was the subject of any Service performed by Seller, which has been subject to misuse, alteration, abuse, negligence, accident, acts of God or sabotage. No action by either party shall operate to extend or revive the foregoing limited warranties without the prior written consent of Seller.

**8. Remedies for Breach.** IN THE EVENT OF ANY BREACH OF WARRANTY BY SELLER, THE PARTIES AGREE THAT SELLER'S LIABILITY SHALL BE LIMITED EXCLUSIVELY TO THE REMEDIES OF REPAIR OR REPLACEMENT (AT SELLER'S SOLE DISCRETION) OF ANY DEFECTIVE PRODUCT OR THE RE-PERFORMANCE OF ANY DEFECTIVE SERVICES COVERED BY THE WARRANTY. In no event shall any repair or replacement of any defective Equipment or Parts, or the re-performance of any defective Services covered by the Seller's warranties in Section 7 extend the length of such warranties beyond the applicable periods specified in Section 7 above.

**9. Limitation of Liability.** NOTWITHSTANDING ANYTHING CONTAINED IN THIS AGREEMENT TO THE CONTRARY, SELLER AND ITS AFFILIATES SHALL NOT BE LIABLE FOR, AND SPECIFICALLY DISCLAIM, ANY LIABILITY FOR ANY: (A) LOST PROFITS AND/OR BUSINESS INTERRUPTION (WHETHER DIRECT OR INDIRECT); AND (B) INCIDENTAL, INDIRECT, CONSEQUENTIAL (WHETHER DIRECT OR INDIRECT) OR OTHER DAMAGES OR LOSSES OF ANY KIND, including without limitation, labor costs, loss of use, equipment rental, third party repairs, investigation costs, personal injury, emotional or mental distress, penalties, loss of service of personnel, or failure of Products to comply with any applicable laws; whether or not arising from breach of contract, warranty, negligence, product liability or otherwise. Notwithstanding anything contained herein to the contrary, in no event shall Seller's liability exceed the total order value.

**10. Limitation of Actions.** Any action for breach of this agreement must be commenced within one (1) year after the cause of action has accrued.

**11. Specification Changes.** In the event Seller incurs additional expense because of changes in specifications or drawings previously approved by Buyer, or in the event Seller is required to modify the ordered Products, perform any additional Services, perform any additional work or supply any additional Products, the additional expense shall be added to the purchase price. Seller shall have the right, in its sole discretion, to accept or reject any changes in specifications requested by Buyer. In no event shall any changes in specifications be made or accepted thirty (30) days prior to launch date or thereafter.

**12. Security Interest.** Buyer grants Seller a security interest in the Products purchased and the proceeds thereof. The security interest shall continue until payment in full of the purchase price and payment and performance by Buyer of all of its other obligations hereunder. Seller is entitled to all remedies of a secured party after default under the Ohio Uniform Commercial Code or other applicable law, including but not limited to the applicable Personal Property Security Act in Canada, in addition to all other rights provided by contract and by operation of law. Buyer agrees to pay to Seller, in addition to the interest on overdue sums due, reasonable attorney fees, court costs and other expenses of Seller incurred in enforcing Seller's rights. The Products purchased shall remain personal property and shall not become or be deemed a fixture or a part of any real estate on which it may be located. Buyer agrees to execute any instrument or document considered necessary by Seller to perfect its security interest in the Products including, but not limited to, financing statements, chattel mortgages, deeds of trust, deeds to secure debt, mortgages or other security instruments.

**13. Insurance.** Until the purchase price of any Product is paid in full or the Service is completed, the Buyer shall provide and maintain insurance equal to the total value of any such Product delivered hereunder against customary casualties and risks; including, but not limited to fire and explosion, and shall also insure against liability for accidents and injuries to the public or to employees, by adding Seller as additional insured with waiver of subrogation, and in an amount satisfactory to Seller. If the Buyer fails to provide such insurance, it then becomes the Buyer's responsibility to notify the Seller so that the Seller may provide same; and the cost thereof shall be added to the contract price. All loss resulting from the failure to affect such insurance shall be assumed by the Buyer.

**14. Return of Products.** Products may be returned only with Seller's prior written consent and upon the following conditions: (i) such Products must be new, unused and undamaged (and not obsolete), in good working order and in first class marketable condition; (ii) such Products must have been originally purchased by Buyer from Seller within the previous twelve (12) month period; and (iii) such Products shall be returned in the same condition as that in which they were sold by Seller to Buyer, and in the original packaging. Notwithstanding the foregoing, wire rope, cut chain, electrical components, special orders of Products or any Products which are altered or manufactured pursuant to Buyer's requirements and specifications are not returnable. The price for the repurchase of such Products shall be the invoice price previously received by Seller from Buyer for the Products in question, net of freight and taxes, and less a restocking fee to be determined by Seller at the time of the return.

**15. Patents, Copyrights, Trademarks, Confidentiality.** No license or other rights under any patents, copyrights or trademarks owned or controlled by Seller or under which Seller is licensed are granted to Buyer or implied by the sale of Products or the provision of Services. Buyer shall not identify as genuine products of Seller Products purchased hereunder which Buyer has treated, modified or altered in any way, nor shall Buyer use Seller's trademarks to identify such products; provided, however, that Buyer may identify such products as utilizing, containing or having been manufactured from genuine products of Seller as treated, modified or altered by Buyer or Buyer's representative, upon written prior approval of Seller. All plans, photographs, designs, drawings, blueprints, manuals, specifications and other documents relating to the business of Seller ("Information") shall be and remain the exclusive property of Seller and shall be treated by Buyer as confidential information and not disclosed, given, loaned, exhibited, sold or transferred to any third party without Seller's prior written approval; provided, however, that these restrictions shall not apply to Information that Buyer can demonstrate: (a) at the time of disclosure, is generally known to the public other than as a result of a breach of this agreement by Buyer; or (b) is already in Buyer's possession at the time of disclosure by from a third party having a right to impart such Information.

**16. Default and Seller's Remedies.** In the event of default by Buyer, all unpaid sums and installments owed to Seller, shall, at the Seller's sole option, become immediately due and payable without notice of any kind to Buyer. In addition to its right of acceleration, Seller may pursue any and all remedies allowed by law or in equity, including but not limited to any and all remedies available to it under the Ohio Uniform Commercial Code. In addition to the foregoing, and not in limitation thereof, Seller shall have the right to set off any credits or amounts owed to Buyer against any amounts owed by Buyer to Seller.

**17. Indemnification by Buyer.** Buyer hereby agrees to indemnify, release, defend and hold harmless Seller, its directors, officers, employees, agents, representatives, successors, and assigns against any and all suits, actions or proceedings at law or in equity (including the costs, expenses and reasonable attorney's fees incurred in connection with the defense of any such matter) and from any and all claims demands, losses, judgments, damages, costs, expenses or liabilities, to any person whatsoever (including Buyer's and Seller's employees or any third party), or damage to any property (including Buyer's property) arising out of or in any way connected with any act, omission, negligence or willful misconduct of Buyer, its directors, officers, employees, agents, representatives, successors or assigns with respect to its purchase, use, operation, maintenance or installation of any Services or any Parts or Equipment furnished hereunder, or any breach by Buyer of these Terms and Conditions of Sale. If Buyer fails to fulfill any of its obligations under this paragraph or this agreement, Buyer agrees to pay Seller all costs, expenses and attorney's fees incurred by Seller to establish or enforce Seller's rights under this paragraph or this agreement. The provisions of this paragraph are in addition to any other rights or obligations set forth in this agreement.

**18. Installation.** Unless otherwise expressly agreed in writing, Buyer shall be solely responsible for the installation and erection of the Products purchased. Although Seller may in some cases provide a serviceman, data and drawings to aid Buyer with installation or start-up, Seller assumes no responsibility for proper installation or support of any Product when installed and disclaims any express or implied warranties with respect to such installation and support. Notwithstanding whether data and drawings are provided or a serviceman aids in the installation, Buyer shall indemnify and hold Seller harmless and at Seller's request, defend Seller from all claims, demands or legal proceedings (including the costs, expenses and reasonable attorney's fees incurred in connection with the defense of any such matter) which may be made or brought against Seller in connection with damage or personal injury arising out of said installation or start-up.

**19. On-Site Services.** In the event that Seller is providing Services at Buyer's worksite (or at a location designated by Buyer), Buyer shall provide Seller free and clear access and an adequate power supply in order to perform the Services. Buyer shall maintain safe working conditions at the worksite, including, without limitation, implementing appropriate procedures regarding hazardous materials and energization and de-energization of power systems. Buyer shall immediately remedy any unsafe working condition at the worksite. Seller shall be entitled to suspend or terminate the Services in the event it determines that the worksite is unsafe. Seller shall have no responsibility or liability for any pre-existing condition of the worksite including, without limitation, violations of safety rules, building codes, zoning ordinances or other laws or regulations ("Regulations"). In the event that any unsafe working condition or failure of the worksite to comply with a Regulation results in an increase in the Seller's cost of, or the time required for, performance of the Services, Seller may make an equitable adjustment in price and schedule. Buyer authorizes Seller to perform the disassembly and inspection of any equipment necessary to provide the Services, including provision of all necessary Parts and labor, and agrees that Seller is not responsible for any damage or loss due to causes beyond Seller's control. Unless expressly agreed in writing, Services do not include architectural/engineering services or structural changes to Buyer's premises.

**20. Additional Terms of Equipment Services.** In the event Seller performs Services on Equipment for Buyer, Buyer hereby authorizes Seller to inspect and disassemble the Equipment provided, and authorizes Seller to perform the Services indicated in the applicable estimate, quote or work order (including provision of all necessary parts and labor). Buyer agrees that Seller is not responsible for: (i) damage or loss to the Equipment, or loss of personal property, caused by fire, theft, or causes beyond Seller's control, or (ii) delays in completion of Services caused by unavailability of parts or other causes. Buyer authorizes Seller and its employees to operate the Equipment on streets, highways or elsewhere for the purpose of testing and/or inspection. Buyer will be subject to a storage fee of \$20 per day for any Equipment left on Seller's premises more than fifteen (15) days after completion of the Services. Buyer grants Seller a security interest and lien in the Equipment and any parts supplied until payment in full of any amounts owed by Buyer to Seller. Seller is entitled to all remedies of a secured party after default under the Uniform Commercial Code in addition to all other rights provided under law or equity. Buyer agrees to pay to Seller, in addition to interest at the rate of 18% annually on overdue sums (or the maximum rate permitted by law), reasonable attorney fees, court costs and other expenses incurred by Seller in enforcing Seller's rights. Buyer agrees to execute any instrument or document considered necessary by Seller to perfect its security interest in the Equipment. In the event Buyer fails to retrieve the Equipment within ninety (90) days after completion of the Services, Buyer grants Seller a power of attorney to sell, or otherwise dispose of, such Equipment and to convey title to a purchaser of such Equipment, and to apply any sale proceeds against any amount owed by Buyer to Seller. In the event of default by Buyer, all unpaid sums owed to Seller shall, at Seller's sole option, become immediately due and payable without notice of any kind to Buyer.

**21. Force Majeure.** The Seller shall not be liable to the Buyer or be deemed to be in breach of this agreement by reason of any delay in performing, or any failure to perform, any of the Seller's obligations in relation to the Products or Services if the delay or failure was due to any cause beyond the reasonable control of the Seller including (without limitation) strike, lockout, riot, civil commotion, fire, accident, explosion, tempest, act of God, war, epidemic, stoppage of transport, terrorist activity, supply shortage or changes in government, governmental agency, laws, regulations or administrative practices.

**22. Anti-Corruption; Export Controls; No Boycotts.** Buyer agrees that it shall, and that any party retained or paid by the Buyer ("Retained Party") shall, comply with all applicable laws including, but not limited to, laws prohibiting public corruption and commercial bribery. Buyer further agrees that it shall, and that any Retained Party shall, comply with all applicable export controls, economic sanctions, embargoes and regulations regarding the export, re-export, shipment, distribution and/or sale of Products, technology, information or warranty related services. Buyer further agrees that it shall not, and any Retained Party shall not, export or re-export Products, technology, information or warranty related services directly or with its knowledge indirectly into Iran, Cuba, Syria, North Korea, the Crimea Region of the Ukraine or Russia without Buyer first obtaining written approval from Seller. Failure to comply strictly with this section and all applicable laws, regulations and licensing/approval requirements shall be grounds for immediate termination of this agreement by Seller. Notwithstanding anything to the contrary contained in any agreement between the Buyer and Seller or in any other document or agreement relating to the Products sold hereunder, Seller will not comply with requests related to the boycott of any country or other jurisdiction, except to the extent such boycott is required by or otherwise not inconsistent with United States law.

**23. Telematics.** If a telematics system is included with the Equipment, the telematics system is administered by a third party (“Teleservice Provider”) and collects a range of operational data about the Equipment including, but not limited to, usage, performance and reliability. Buyer consents to Seller’s obtaining such data from the Teleservice Provider for warranty, product improvement, marketing and customer support purposes. In addition to the foregoing, Buyer consents to Seller’s collection, management and reporting of data (personal and non-personal) about the Equipment including, but not limited to, fuel consumption, up/down times, operation, defects, parts replacement, movement and location. Buyer shall gain any prior explicit consent from its customers and/or any third party, as required by applicable laws, enabling Seller and/or third parties to provide teleservices and data to Buyer. Buyer shall comply with all applicable laws relating to the provision of teleservices, including without limitations any applicable data protection laws.

**24. Construction and Severability.** This agreement constitutes the entire agreement between the parties regarding the subject matter hereto and shall be construed and enforced in accordance with the laws of the State of Ohio. Seller shall not be bound by any agent's, employees or any other representation, promise or inducement not set forth herein. The invalidity or unenforceability of any provisions of this agreement shall not affect any other provision and this agreement shall be construed in all respects as if such invalid or unenforceable provision were omitted.

**25. Jurisdiction.** The parties agree that the proper and exclusive forum and venue in all legal actions brought to enforce or construe any of the provisions of this sales order agreement shall be in the United States District Court, Northern District of Ohio or, if federal jurisdiction is lacking in such legal action, in the state courts in Cleveland, Ohio.

**26. No Assignment.** No rights arising under this agreement may be assigned by the Buyer unless expressly agreed to in writing by the Seller.

**27. Miscellaneous.** Buyer represents that: (i) it is solvent and has the financial ability to pay for the Products or Services; and (ii) it has all requisite right, power and authority to perform its obligations under this agreement.

Prepared for:  
 Sheldon Seward  
 TEREX UTILITIES BB  
 500 OAKWOOD RD  
 WATERTOWN, SD 57201  
 Phone: 605-882-5515

Prepared by:  
 Truman Ingram  
 FOUR STAR FREIGHTLINER OF  
 MONTGOMERY  
 3140 HAYNEVILLE ROAD  
 MONTGOMERY, AL 36108  
 Phone: 334-263-1085

## DIMENSIONS

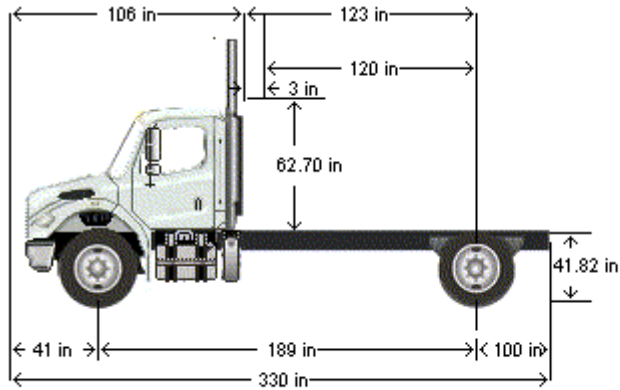

## VEHICLE SPECIFICATIONS SUMMARY - DIMENSIONS

Model .....	M2106
Wheelbase (545) .....	4800MM (189 INCH) WHEELBASE
Rear Frame Overhang (552) .....	2550MM (100 INCH) REAR FRAME OVERHANG
Fifth Wheel (578) .....	NO FIFTH WHEEL
Mounting Location (577) .....	NO FIFTH WHEEL LOCATION
Maximum Forward Position (in) .....	0
Maximum Rearward Position (in) .....	0
Amount of Slide Travel (in) .....	0
Slide Increment (in) .....	0
Desired Slide Position (in) .....	0.0
Cab Size (829) .....	106 INCH BBC FLAT ROOF ALUMINUM CONVENTIONAL CAB
Sleeper (682) .....	NO SLEEPER BOX/SLEEPER CAB
Exhaust System (016) .....	RH OUTBOARD UNDER STEP MOUNTED HORIZONTAL AFTERTREATMENT SYSTEM ASSEMBLY WITH RH B-PILLAR MOUNTED VERTICAL TAILPIPE



**Prepared for:**  
 Sheldon Seward  
 TEREX UTILITIES BB  
 500 OAKWOOD RD  
 WATERTOWN, SD 57201  
 Phone: 605-882-5515

**Prepared by:**  
 Truman Ingram  
 FOUR STAR FREIGHTLINER OF  
 MONTGOMERY  
 3140 HAYNEVILLE ROAD  
 MONTGOMERY, AL 36108  
 Phone: 334-263-1085

**TABLE SUMMARY - DIMENSIONS**

Dimensions	Inches
Bumper to Back of Cab (BBC)	106.3
Bumper to Centerline of Front Axle (BA)	40.7
Min. Cab to Body Clearance (CB)	3.0
Back of Cab to Centerline of Rear Axle(s) (CA)	123.4
Effective Back of Cab to Centerline of Rear Axle(s) (Effective CA)	120.4
Back of Cab Protrusions (Exhaust/Intake) (CP)	2.0
Back of Cab Protrusions (Side Extenders/Trim Tab) (CP)	0.0
Back of Cab Protrusions (CNG Tank)	0.0
Back of Cab Clearance (CL)	3.0
Back of Cab to End of Frame	223.8
Cab Height (CH)	62.7
Wheelbase (WB)	189.0
Frame Overhang (OH)	100.4
Overall Frame Length	318.8
Overall Length (OAL)	330.1
Rear Axle Spacing	0.0
Unladen Frame Height at Centerline of Rear Axle	41.8

Performance calculations are estimates only. If performance calculations are critical, please contact Customer Application Engineering.

**Prepared for:**  
 Sheldon Seward  
 TEREX UTILITIES BB  
 500 OAKWOOD RD  
 WATERTOWN, SD 57201  
 Phone: 605-882-5515

**Prepared by:**  
 Truman Ingram  
 FOUR STAR FREIGHTLINER OF  
 MONTGOMERY  
 3140 HAYNEVILLE ROAD  
 MONTGOMERY, AL 36108  
 Phone: 334-263-1085

## S P E C I F I C A T I O N   P R O P O S A L

Data Code	Description	Weight Front	Weight Rear
<b>Price Level</b>			
PRL-23M	M2 PRL-23M (EFF:01/21/20)		
<b>Data Version</b>			
DRL-010	SPECPRO21 DATA RELEASE VER 010		
<b>Vehicle Configuration</b>			
001-172	M2 106 CONVENTIONAL CHASSIS	5,709	3,503
004-223	2023 MODEL YEAR SPECIFIED		
002-004	SET BACK AXLE - TRUCK		
019-001	TRAILER TOWING PROVISION AT END OF FRAME FOR TRUCK	10	10
003-001	LH PRIMARY STEERING LOCATION		
<b>General Service</b>			
AA1-003	TRUCK/TRAILER CONFIGURATION		
AA6-001	DOMICILED, USA 50 STATES (INCLUDING CALIFORNIA AND CARB OPT-IN STATES)		
A85-010	UTILITY/REPAIR/MAINTENANCE SERVICE		
A84-1UT	UTILITY BUSINESS SEGMENT		
AA4-011	FIXED LOAD COMMODITY		
AA5-006	TERRAIN/DUTY: 10% (SOME) OF THE TIME, IN TRANSIT, IS SPENT ON NON-PAVED ROADS		
AB1-008	MAXIMUM 8% EXPECTED GRADE		
AB5-003	MAINTAINED GRAVEL OR CRUSHED ROCK - MOST SEVERE IN-TRANSIT (BETWEEN SITES) ROAD SURFACE		
995-091	MEDIUM TRUCK WARRANTY		
A66-99D	EXPECTED FRONT AXLE(S) LOAD : 13220.0 lbs		
A68-99D	EXPECTED REAR DRIVE AXLE(S) LOAD : 21000.0 lbs		
A63-99D	EXPECTED GROSS VEHICLE WEIGHT CAPACITY : 33000.0 lbs (Derated)		

Prepared for:  
 Sheldon Seward  
 TEREX UTILITIES BB  
 500 OAKWOOD RD  
 WATERTOWN, SD 57201  
 Phone: 605-882-5515

Prepared by:  
 Truman Ingram  
 FOUR STAR FREIGHTLINER OF  
 MONTGOMERY  
 3140 HAYNEVILLE ROAD  
 MONTGOMERY, AL 36108  
 Phone: 334-263-1085

Data Code	Description	Weight Front	Weight Rear
A70-99D	EXPECTED GROSS COMBINATION WEIGHT : 45000.0 lbs		
<b>Truck Service</b>			
AA3-006	UTILITY BODY		
AF3-2A5	TEREX		
AF7-99D	EXPECTED BODY/PAYLOAD CG HEIGHT ABOVE FRAME "XX" INCHES : 32.0 in		
<b>Engine</b>			
101-21X	CUM B6.7 300 HP @ 2600 RPM, 2600 GOV, 660 LB-FT @ 1600 RPM		
<b>Electronic Parameters</b>			
79A-075	75 MPH ROAD SPEED LIMIT		
79B-000	CRUISE CONTROL SPEED LIMIT SAME AS ROAD SPEED LIMIT		
79K-005	PTO MODE ENGINE RPM LIMIT - 900 RPM		
79M-001	PTO MODE BRAKE OVERRIDE - SERVICE BRAKE APPLIED		
79P-002	PTO RPM WITH CRUISE SET SWITCH - 700 RPM		
79Q-002	PTO RPM WITH CRUISE RESUME SWITCH - 700 RPM		
79S-001	PTO MODE CANCEL VEHICLE SPEED - 5 MPH		
79U-007	PTO GOVERNOR RAMP RATE - 250 RPM PER SECOND		
79W-001	ONE REMOTE PTO SPEED		
79X-001	PTO SPEED 1 SETTING - 700 RPM		
80G-002	PTO MINIMUM RPM - 700		
80J-001	REGEN INHIBIT SPEED THRESHOLD - 0 MPH		
<b>Engine Equipment</b>			
99C-021	2016 ONBOARD DIAGNOSTICS/2010 EPA/CARB/GHG21 CONFIGURATION		
99D-011	2008 CARB EMISSION CERTIFICATION - CLEAN IDLE (INCLUDES 6X4 INCH LABEL ON LOWER FORWARD CORNER OF DRIVER DOOR)		
13E-001	STANDARD OIL PAN		
105-001	ENGINE MOUNTED OIL CHECK AND FILL		
014-099	SIDE OF HOOD AIR INTAKE WITH FIREWALL MOUNTED DONALDSON AIR CLEANER		
124-1D7	DR 12V 160 AMP 28-SI QUADRAMOUNT PAD ALTERNATOR WITH REMOTE BATTERY VOLT SENSE		

Prepared for:  
 Sheldon Seward  
 TEREX UTILITIES BB  
 500 OAKWOOD RD  
 WATERTOWN, SD 57201  
 Phone: 605-882-5515

Prepared by:  
 Truman Ingram  
 FOUR STAR FREIGHTLINER OF  
 MONTGOMERY  
 3140 HAYNEVILLE ROAD  
 MONTGOMERY, AL 36108  
 Phone: 334-263-1085

Data Code	Description	Weight Front	Weight Rear
292-205	(2) DTNA GENUINE, FLOODED STARTING, MIN 1900CCA, 350RC, THREADED STUD BATTERIES		
290-017	BATTERY BOX FRAME MOUNTED		
* 281-008	STANDARD BATTERY JUMPERS W / Additional ground stud mounted 12 inches aft of the spring shackle		
282-001	SINGLE BATTERY BOX FRAME MOUNTED LH SIDE UNDER CAB		
291-017	WIRE GROUND RETURN FOR BATTERY CABLES WITH ADDITIONAL FRAME GROUND RETURN		
289-001	NON-POLISHED BATTERY BOX COVER		
87P-001	CAB AUXILIARY POWER CABLE	5	
295-029	POSITIVE AND NEGATIVE POSTS FOR JUMPSTART LOCATED ON FRAME NEXT TO STARTER	2	
107-032	CUMMINS TURBOCHARGED 18.7 CFM AIR COMPRESSOR WITH INTERNAL SAFETY VALVE		
108-002	STANDARD MECHANICAL AIR COMPRESSOR GOVERNOR		
131-013	AIR COMPRESSOR DISCHARGE LINE		
152-041	ELECTRONIC ENGINE INTEGRAL SHUTDOWN PROTECTION SYSTEM		
128-076	CUMMINS ENGINE INTEGRAL BRAKE WITH VARIABLE GEOMETRY TURBO ON/OFF	20	
016-1C2	RH OUTBOARD UNDER STEP MOUNTED HORIZONTAL AFTERTREATMENT SYSTEM ASSEMBLY WITH RH B-PILLAR MOUNTED VERTICAL TAILPIPE	30	25
28F-007	ENGINE AFTERTREATMENT DEVICE, AUTOMATIC OVER THE ROAD ACTIVE REGENERATION AND DASH MOUNTED SINGLE REGENERATION REQUEST/INHIBIT SWITCH		
239-026	10 FOOT 06 INCH (126 INCH+0/-5.9 INCH) EXHAUST SYSTEM HEIGHT		
237-1CR	RH CURVED VERTICAL TAILPIPE B-PILLAR MOUNTED ROUTED FROM STEP		
23U-001	6 GALLON DIESEL EXHAUST FLUID TANK		
30N-003	100 PERCENT DIESEL EXHAUST FLUID FILL		
43X-002	LH MEDIUM DUTY STANDARD DIESEL EXHAUST FLUID TANK LOCATION		
23Y-001	STANDARD DIESEL EXHAUST FLUID PUMP MOUNTING		
43Y-001	STANDARD DIESEL EXHAUST FLUID TANK CAP		

Prepared for:  
 Sheldon Seward  
 TEREX UTILITIES BB  
 500 OAKWOOD RD  
 WATERTOWN, SD 57201  
 Phone: 605-882-5515

Prepared by:  
 Truman Ingram  
 FOUR STAR FREIGHTLINER OF  
 MONTGOMERY  
 3140 HAYNEVILLE ROAD  
 MONTGOMERY, AL 36108  
 Phone: 334-263-1085

Data Code	Description	Weight Front	Weight Rear
242-011	ALUMINUM AFTERTREATMENT DEVICE/MUFFLER/TAILPIPE SHIELD(S)		
273-058	AIR POWERED ON/OFF ENGINE FAN CLUTCH		
276-001	AUTOMATIC FAN CONTROL WITHOUT DASH SWITCH, NON ENGINE MOUNTED		
110-003	CUMMINS SPIN ON FUEL FILTER		
118-001	FULL FLOW OIL FILTER		
266-078	950 SQUARE INCH ALUMINUM RADIATOR	50	
103-039	ANTIFREEZE TO -34F, OAT (NITRITE AND SILICATE FREE) EXTENDED LIFE COOLANT		
171-007	GATES BLUE STRIPE COOLANT HOSES OR EQUIVALENT		
172-001	CONSTANT TENSION HOSE CLAMPS FOR COOLANT HOSES		
270-016	RADIATOR DRAIN VALVE		
168-002	LOWER RADIATOR GUARD		
138-010	PHILLIPS-TEMRO 750 WATT/115 VOLT BLOCK HEATER	4	
140-053	BLACK PLASTIC ENGINE HEATER RECEPTACLE MOUNTED UNDER LH DOOR		
134-001	ALUMINUM FLYWHEEL HOUSING		
132-004	ELECTRIC GRID AIR INTAKE WARMER		
155-058	DELCO 12V 38MT HD STARTER WITH INTEGRATED MAGNETIC SWITCH		

### Transmission

342-584	ALLISON 3500 RDS AUTOMATIC TRANSMISSION WITH PTO PROVISION	200	60
---------	--	-----	----

### Transmission Equipment

343-339	ALLISON VOCATIONAL PACKAGE 223 - AVAILABLE ON 3000/4000 PRODUCT FAMILIES WITH VOCATIONAL MODELS RDS, HS, MH AND TRV		
84B-012	ALLISON VOCATIONAL RATING FOR ON/OFF HIGHWAY APPLICATIONS AVAILABLE WITH ALL PRODUCT FAMILIES		
84C-022	PRIMARY MODE GEARS, LOWEST GEAR 1, START GEAR 1, HIGHEST GEAR 5, AVAILABLE FOR 3000/4000 PRODUCT FAMILIES ONLY		
84D-022	SECONDARY MODE GEARS, LOWEST GEAR 1, START GEAR 1, HIGHEST GEAR 5, AVAILABLE FOR 3000/4000 PRODUCT FAMILIES ONLY		

**Prepared for:**  
 Sheldon Seward  
 TEREX UTILITIES BB  
 500 OAKWOOD RD  
 WATERTOWN, SD 57201  
 Phone: 605-882-5515

**Prepared by:**  
 Truman Ingram  
 FOUR STAR FREIGHTLINER OF  
 MONTGOMERY  
 3140 HAYNEVILLE ROAD  
 MONTGOMERY, AL 36108  
 Phone: 334-263-1085

Data Code	Description	Weight Front	Weight Rear
84E-017	S5 PERFORMANCE LIMITING PRIMARY SHIFT SCHEDULE, AVAILABLE FOR 3000/4000 PRODUCT FAMILIES ONLY		
84F-018	S7 ECONOMY LIMITING SECONDARY SHIFT SCHEDULE, AVAILABLE FOR 3000/4000 PRODUCT FAMILIES ONLY		
84G-018	2600 RPM PRIMARY MODE SHIFT SPEED		
84H-016	2400 RPM SECONDARY MODE SHIFT SPEED		
84J-000	ENGINE BRAKE RANGE PRESELECT RECOMMENDED BY DTNA AND ALLISON, THIS DEFINED BY ENGINE AND VOCATIONAL USAGE		
84K-000	ENGINE BRAKE RANGE ALTERNATE PRESELECT RECOMMENDED BY DTNA AND ALLISON, THIS DEFINED BY ENGINE AND VOCATIONAL USAGE		
84N-200	FUEL SENSE 2.0 DISABLED - PERFORMANCE - TABLE BASED		
84U-000	DRIVER SWITCH INPUT - DEFAULT - NO SWITCHES		
353-023	VEHICLE INTERFACE WIRING CONNECTOR WITHOUT BLUNT CUTS, AT END OF FRAME		
34C-001	ELECTRONIC TRANSMISSION CUSTOMER ACCESS CONNECTOR FIREWALL MOUNTED		
362-823	CUSTOMER INSTALLED CHELSEA 280 SERIES PTO		
363-001	PTO MOUNTING, LH SIDE OF MAIN TRANSMISSION		
341-018	MAGNETIC PLUGS, ENGINE DRAIN, TRANSMISSION DRAIN, AXLE(S) FILL AND DRAIN		
345-003	PUSH BUTTON ELECTRONIC SHIFT CONTROL, DASH MOUNTED		
97G-004	TRANSMISSION PROGNOSTICS - ENABLED 2013		
370-015	WATER TO OIL TRANSMISSION COOLER, IN RADIATOR END TANK		
346-013	TRANSMISSION OIL CHECK AND FILL WITH CROSSOVER TO CLEAR LH PTO AND DIRECT MOUNT PUMP		
35T-001	SYNTHETIC TRANSMISSION FLUID (TES-295 COMPLIANT)		

### Front Axle and Equipment

400-1A7	DETROIT DA-F-13.3-3 13,300# FF1 71.5 KPI/3.74 DROP SINGLE FRONT AXLE
---------	--

Prepared for:  
 Sheldon Seward  
 TEREX UTILITIES BB  
 500 OAKWOOD RD  
 WATERTOWN, SD 57201  
 Phone: 605-882-5515

Prepared by:  
 Truman Ingram  
 FOUR STAR FREIGHTLINER OF  
 MONTGOMERY  
 3140 HAYNEVILLE ROAD  
 MONTGOMERY, AL 36108  
 Phone: 334-263-1085

Data Code	Description	Weight Front	Weight Rear
402-049	MERITOR 16.5X5 Q+ CAST SPIDER CAM FRONT BRAKES, DOUBLE ANCHOR, FABRICATED SHOES		
403-002	NON-ASBESTOS FRONT BRAKE LINING		
419-001	CAST IRON OUTBOARD FRONT BRAKE DRUMS		
409-006	FRONT OIL SEALS		
408-001	VENTED FRONT HUB CAPS WITH WINDOW, CENTER AND SIDE PLUGS - OIL		
416-022	STANDARD SPINDLE NUTS FOR ALL AXLES		
405-002	MERITOR AUTOMATIC FRONT SLACK ADJUSTERS		
536-050	TRW THP-60 POWER STEERING		
539-003	POWER STEERING PUMP		
534-015	2 QUART SEE THROUGH POWER STEERING RESERVOIR		
40T-001	MINERAL SAE 80/90 FRONT AXLE LUBE		
<b>Front Suspension</b>			
620-1D8	13,300# TAPERLEAF FRONT SUSPENSION	75	
619-005	MAINTENANCE FREE RUBBER BUSHINGS - FRONT SUSPENSION		
* 62H-012	FRONT SUSPENSION WITH LEFT HAND AND RIGHT HAND OFFSET SHACKLE BRACKETS		
410-001	FRONT SHOCK ABSORBERS		
<b>Rear Axle and Equipment</b>			
420-1N0	MS-21-14X 21,000# R-SERIES SINGLE REAR AXLE		10
421-557	5.57 REAR AXLE RATIO		
424-001	IRON REAR AXLE CARRIER WITH STANDARD AXLE HOUSING		
386-073	MXL 17T MERITOR EXTENDED LUBE MAIN DRIVELINE WITH HALF ROUND YOKES		
452-001	DRIVER CONTROLLED TRACTION DIFFERENTIAL - SINGLE REAR AXLE		20
878-018	(1) DRIVER CONTROLLED DIFFERENTIAL LOCK REAR VALVE FOR SINGLE DRIVE AXLE		
87B-004	BLINKING LAMP WITH EACH MODE SWITCH, DIFFERENTIAL UNLOCK WITH IGNITION OFF, ACTIVE <5 MPH		
423-020	MERITOR 16.5X7 Q+ CAST SPIDER CAM REAR BRAKES, DOUBLE ANCHOR, FABRICATED SHOES		
433-002	NON-ASBESTOS REAR BRAKE LINING		



Prepared for:  
 Sheldon Seward  
 TEREX UTILITIES BB  
 500 OAKWOOD RD  
 WATERTOWN, SD 57201  
 Phone: 605-882-5515

Prepared by:  
 Truman Ingram  
 FOUR STAR FREIGHTLINER OF  
 MONTGOMERY  
 3140 HAYNEVILLE ROAD  
 MONTGOMERY, AL 36108  
 Phone: 334-263-1085

Data Code	Description	Weight Front	Weight Rear
434-012	BRAKE CAMS AND CHAMBERS ON REAR SIDE OF DRIVE AXLE(S)		
451-023	CONMET CAST IRON REAR BRAKE DRUMS		
440-006	REAR OIL SEALS		
426-100	WABCO TRISTOP D LONGSTROKE 1-DRIVE AXLE SPRING PARKING CHAMBERS		
428-002	MERITOR AUTOMATIC REAR SLACK ADJUSTERS		
41T-002	CURRENT AVAILABLE SYNTHETIC 75W-90 REAR AXLE LUBE		
<b>Rear Suspension</b>			
622-1MJ	23,000# 52 INCH VARIABLE RATE MULTI-LEAF SPRING REAR SUSPENSION WITH LEAF SPRING HELPER		110
621-001	SPRING SUSPENSION - NO AXLE SPACERS		
431-001	STANDARD AXLE SEATS IN AXLE CLAMP GROUP		
<b>Brake System</b>			
018-002	AIR BRAKE PACKAGE		
490-100	WABCO 4S/4M ABS		
871-001	REINFORCED NYLON, FABRIC BRAID AND WIRE BRAID CHASSIS AIR LINES		
904-001	FIBER BRAID PARKING BRAKE HOSE		
412-001	STANDARD BRAKE SYSTEM VALVES		
46D-002	STANDARD AIR SYSTEM PRESSURE PROTECTION SYSTEM		
413-002	STD U.S. FRONT BRAKE VALVE		
432-003	RELAY VALVE WITH 5-8 PSI CRACK PRESSURE, NO REAR PROPORTIONING VALVE		
480-088	WABCO SYSTEM SAVER HP WITH INTEGRAL AIR GOVERNOR AND HEATER		
479-012	AIR DRYER MOUNTED UNDER HOOD		
460-001	STEEL AIR BRAKE RESERVOIRS		
607-001	CLEAR FRAME RAILS FROM BACK OF CAB TO FRONT REAR SUSPENSION BRACKET, BOTH RAILS OUTBOARD		
477-004	PULL CABLES ON ALL AIR RESERVOIR(S)		
<b>Trailer Connections</b>			
*	914-009	AIR CONNECTIONS AT END OF FRAME ONLY WITH ANCHOR COUPLINGS FOR TRUCK	
		END AIRLINES AT THE SECOND TO LAST CROSS MEMBER ON RH SIDE	

Prepared for:  
 Sheldon Seward  
 TEREX UTILITIES BB  
 500 OAKWOOD RD  
 WATERTOWN, SD 57201  
 Phone: 605-882-5515

Prepared by:  
 Truman Ingram  
 FOUR STAR FREIGHTLINER OF  
 MONTGOMERY  
 3140 HAYNEVILLE ROAD  
 MONTGOMERY, AL 36108  
 Phone: 334-263-1085

Data Code	Description	Weight Front	Weight Rear
296-027	PRIMARY CONNECTOR/RECEPTACLE WIRED FOR COMBINATION STOP/TURN, CENTER PIN POWERED THROUGH IGNITION WITH STOP SIGNAL PREWIRE PACKAGE		
297-001	SAE J560 7-WAY PRIMARY TRAILER CABLE RECEPTACLE MOUNTED END OF FRAME		
335-004	UPGRADED CHASSIS MULTIPLEXING UNIT		
32A-002	UPGRADED BULKHEAD MULTIPLEXING UNIT		
<b>Wheelbase &amp; Frame</b>			
545-480	4800MM (189 INCH) WHEELBASE		
546-102	7/16X3-9/16X11-1/8 INCH STEEL FRAME (11.11MMX282.6MM/0.437X11.13 INCH) 120KSI	160	280
552-063	2550MM (100 INCH) REAR FRAME OVERHANG		
55W-009	FRAME OVERHANG RANGE: 91 INCH TO 100 INCH	-50	210
AC8-99D	CALC'D BACK OF CAB TO REAR SUSP C/L (CA) : 123.43 in		
AE8-99D	CALCULATED EFFECTIVE BACK OF CAB TO REAR SUSPENSION C/L (CA) : 120.43 in		
AE4-99D	CALC'D FRAME LENGTH - OVERALL : 318.77		
FSS-0LH	CALCULATED FRAME SPACE LH SIDE : 87.87 in		
FSS-0RH	CALCULATED FRAME SPACE RH SIDE : 109.43 in		
AM6-99D	CALC'D SPACE AVAILABLE FOR DECKPLATE : 117.45 in		
553-001	SQUARE END OF FRAME		
550-001	FRONT CLOSING CROSSMEMBER		
559-001	STANDARD WEIGHT ENGINE CROSSMEMBER		
561-001	STANDARD CROSSMEMBER BACK OF TRANSMISSION		
562-001	STANDARD MIDSHIP #1 CROSSMEMBER(S)		
572-001	STANDARD REAR MOST CROSSMEMBER		
565-001	STANDARD SUSPENSION CROSSMEMBER		
<b>Chassis Equipment</b>			
556-1AP	THREE-PIECE 14 INCH PAINTED STEEL BUMPER WITH COLLAPSIBLE ENDS	30	
558-001	FRONT TOW HOOKS - FRAME MOUNTED	15	
574-001	BUMPER MOUNTING FOR SINGLE LICENSE PLATE		
586-024	FENDER AND FRONT OF HOOD MOUNTED FRONT MUDFLAPS		

Prepared for:  
 Sheldon Seward  
 TEREX UTILITIES BB  
 500 OAKWOOD RD  
 WATERTOWN, SD 57201  
 Phone: 605-882-5515

Prepared by:  
 Truman Ingram  
 FOUR STAR FREIGHTLINER OF  
 MONTGOMERY  
 3140 HAYNEVILLE ROAD  
 MONTGOMERY, AL 36108  
 Phone: 334-263-1085

Data Code	Description	Weight Front	Weight Rear
551-007	GRADE 8 THREADED HEX HEADED FRAME FASTENERS		
605-103	D15-28195-000 CENTER PUNCH TO MARK CENTERLINE OF REAR SUSPENSION ON TOP FLANGE OF FRAME		
<b>Fuel Tanks</b>			
204-215	50 GALLON/189 LITER SHORT RECTANGULAR ALUMINUM FUEL TANK - LH	20	
218-005	RECTANGULAR FUEL TANK(S)		
215-005	PLAIN ALUMINUM/PAINTED STEEL FUEL/HYDRAULIC TANK(S) WITH PAINTED BANDS		
212-007	FUEL TANK(S) FORWARD		
664-001	PLAIN STEP FINISH		
205-001	FUEL TANK CAP(S)		
122-1J1	DETROIT FUEL/WATER SEPARATOR WITH WATER IN FUEL SENSOR, HAND PRIMER AND 12 VOLT PREHEATER"	-5	
216-020	EQUIFLO INBOARD FUEL SYSTEM		
202-016	HIGH TEMPERATURE REINFORCED NYLON FUEL LINE		
<b>Tires</b>			
093-1YX	CONTINENTAL HSC3 11R22.5 16 PLY RADIAL FRONT TIRES	48	
094-12P	CONTINENTAL HDR2+ 11R22.5 14 PLY RADIAL REAR TIRES		92
<b>Hubs</b>			
418-060	CONMET PRESET PLUS PREMIUM IRON FRONT HUBS		
450-060	CONMET PRESET PLUS PREMIUM IRON REAR HUBS		
<b>Wheels</b>			
502-657	ACCURIDE 51408 ACCU-LITE 22.5X8.25 10-HUB PILOT 6.16 INSET 2-HAND STEEL DISC FRONT WHEELS		
505-657	ACCURIDE 51408 ACCU-LITE 22.5X8.25 10-HUB PILOT 2-HAND STEEL DISC REAR WHEELS		
496-011	FRONT WHEEL MOUNTING NUTS		
497-011	REAR WHEEL MOUNTING NUTS		
<b>Cab Exterior</b>			

**Prepared for:**  
 Sheldon Seward  
 TEREX UTILITIES BB  
 500 OAKWOOD RD  
 WATERTOWN, SD 57201  
 Phone: 605-882-5515

**Prepared by:**  
 Truman Ingram  
 FOUR STAR FREIGHTLINER OF  
 MONTGOMERY  
 3140 HAYNEVILLE ROAD  
 MONTGOMERY, AL 36108  
 Phone: 334-263-1085

Data Code	Description	Weight Front	Weight Rear
829-071	106 INCH BBC FLAT ROOF ALUMINUM CONVENTIONAL CAB		
650-008	AIR CAB MOUNTING		
678-998	NO GRAB HANDLES		
646-023	HOOD MOUNTED CHROMED PLASTIC GRILLE		
65X-003	CHROME HOOD MOUNTED AIR INTAKE GRILLE		
644-004	FIBERGLASS HOOD		
727-1AF	SINGLE 14 INCH ROUND HADLEY AIR HORN UNDER LH DECK	4	
726-001	SINGLE ELECTRIC HORN		
728-001	SINGLE HORN SHIELD		
657-001	DOOR LOCKS AND IGNITION SWITCH KEYED THE SAME		
78G-002	KEY QUANTITY OF 2		
575-001	REAR LICENSE PLATE MOUNT END OF FRAME		
312-038	INTEGRAL HEADLIGHT/MARKER ASSEMBLY WITH CHROME BEZEL		
302-001	(5) AMBER MARKER LIGHTS		
294-090	OMIT STOP/TAIL/BACKUP LIGHTS AND PROVIDE WIRING FOR COMBINED STOP/TURN LIGHTS TO FOUR FEET BEYOND END OF FRAME		-5
300-015	STANDARD FRONT TURN SIGNAL LAMPS		
744-1BH	DUAL WEST COAST MOLDED-IN COLOR MIRRORS		
797-001	DOOR MOUNTED MIRRORS		
796-001	102 INCH EQUIPMENT WIDTH		
743-1AP	LH AND RH 8 INCH MOLDED-IN COLOR CONVEX MIRRORS MOUNTED UNDER PRIMARY MIRRORS		
729-001	STANDARD SIDE/REAR REFLECTORS		
768-043	63X14 INCH TINTED REAR WINDOW		
661-003	TINTED DOOR GLASS LH AND RH WITH TINTED NON-OPERATING WING WINDOWS		
654-027	RH AND LH ELECTRIC POWERED WINDOWS, PASSENGER SWITCHES ON DOOR(S)	4	
663-013	1-PIECE SOLAR GREEN GLASS WINDSHIELD		
659-019	2 GALLON WINDSHIELD WASHER RESERVOIR WITHOUT FLUID LEVEL INDICATOR, FRAME MOUNTED		

**Cab Interior**

707-1AK OPAL GRAY VINYL INTERIOR

Prepared for:  
 Sheldon Seward  
 TEREX UTILITIES BB  
 500 OAKWOOD RD  
 WATERTOWN, SD 57201  
 Phone: 605-882-5515

Prepared by:  
 Truman Ingram  
 FOUR STAR FREIGHTLINER OF  
 MONTGOMERY  
 3140 HAYNEVILLE ROAD  
 MONTGOMERY, AL 36108  
 Phone: 334-263-1085

Data Code	Description	Weight Front	Weight Rear
706-013	MOLDED PLASTIC DOOR PANEL		
708-013	MOLDED PLASTIC DOOR PANEL		
772-006	BLACK MATS WITH SINGLE INSULATION		
785-001	DASH MOUNTED ASH TRAYS AND LIGHTER		
691-008	FORWARD ROOF MOUNTED CONSOLE WITH UPPER STORAGE COMPARTMENTS WITHOUT NETTING		
694-010	IN DASH STORAGE BIN		
742-007	(2) CUP HOLDERS LH AND RH DASH		
680-006	GRAY/CHARCOAL FLAT DASH		
700-002	HEATER, DEFROSTER AND AIR CONDITIONER		
701-001	STANDARD HVAC DUCTING		
703-005	MAIN HVAC CONTROLS WITH RECIRCULATION SWITCH		
170-015	STANDARD HEATER PLUMBING		
130-041	VALEO HEAVY DUTY A/C REFRIGERANT COMPRESSOR		
702-002	BINARY CONTROL, R-134A		
739-033	STANDARD INSULATION		
285-013	SOLID-STATE CIRCUIT PROTECTION AND FUSES		
280-007	12V NEGATIVE GROUND ELECTRICAL SYSTEM		
324-011	DOMED DOOR ACTIVATED LH AND RH, DUAL READING LIGHTS, FORWARD CAB ROOF		
655-005	LH AND RH ELECTRIC DOOR LOCKS		
284-023	(1) 12 VOLT POWER SUPPLY IN DASH		
756-338	BASIC (L1) ISRI HIGH BACK AIR SUSPENSION DRIVERS SEAT WITH MECHANICAL LUMBAR AND INTEGRATED CUSHION EXTENSION	30	
760-235	2 MAN TOOL BOX MID BACK NON SUSPENSION PASSENGER SEAT	20	
711-004	LH AND RH INTEGRAL DOOR PANEL ARMRESTS		
758-036	VINYL WITH VINYL INSERT DRIVER SEAT		
761-036	VINYL WITH VINYL INSERT PASSENGER SEAT		
763-101	BLACK SEAT BELTS		
532-002	ADJUSTABLE TILT AND TELESCOPING STEERING COLUMN	10	
540-015	4-SPOKE 18 INCH (450MM) STEERING WHEEL		
765-002	DRIVER AND PASSENGER INTERIOR SUN VISORS		

### Instruments & Controls

Prepared for:  
 Sheldon Seward  
 TEREX UTILITIES BB  
 500 OAKWOOD RD  
 WATERTOWN, SD 57201  
 Phone: 605-882-5515

Prepared by:  
 Truman Ingram  
 FOUR STAR FREIGHTLINER OF  
 MONTGOMERY  
 3140 HAYNEVILLE ROAD  
 MONTGOMERY, AL 36108  
 Phone: 334-263-1085

Data Code	Description	Weight Front	Weight Rear
732-004	GRAY DRIVER INSTRUMENT PANEL		
734-004	GRAY CENTER INSTRUMENT PANEL		
870-001	BLACK GAUGE BEZELS		
486-006	LOW AIR PRESSURE INDICATOR LIGHT AND AUDIBLE ALARM WITH (1) ADDITIONAL PARK SWITCH FOR CUSTOMER USE		
840-002	2 INCH PRIMARY AND SECONDARY AIR PRESSURE GAUGES		
198-025	INTAKE MOUNTED AIR RESTRICTION INDICATOR WITHOUT GRADUATIONS		
149-013	ELECTRONIC CRUISE CONTROL WITH SWITCHES IN LH SWITCH PANEL		
156-007	KEY OPERATED IGNITION SWITCH AND INTEGRAL START POSITION; 4 POSITION OFF/RUN/START/ACCESSORY		
811-042	ICU3S, 132X48 DISPLAY WITH DIAGNOSTICS, 28 LED WARNING LAMPS AND DATA LINKED		
160-038	HEAVY DUTY ONBOARD DIAGNOSTICS INTERFACE CONNECTOR LOCATED BELOW LH DASH		
844-001	2 INCH ELECTRIC FUEL GAUGE		
148-003	PROGRAMMABLE RPM CONTROL - ELECTRONIC ENGINE		
856-001	ELECTRICAL ENGINE COOLANT TEMPERATURE GAUGE		
864-001	2 INCH TRANSMISSION OIL TEMPERATURE GAUGE		
830-017	ENGINE AND TRIP HOUR METERS INTEGRAL WITHIN DRIVER DISPLAY		
372-051	CUSTOMER FURNISHED AND INSTALLED PTO CONTROLS		
852-002	ELECTRIC ENGINE OIL PRESSURE GAUGE		
679-001	OVERHEAD INSTRUMENT PANEL		
746-137	AM/FM/WB WORLD TUNER RADIO WITH BLUETOOTH, USB AND AUXILIARY INPUTS, J1939	10	
747-001	DASH MOUNTED RADIO		
750-002	(2) RADIO SPEAKERS IN CAB		
753-008	AM/FM ANTENNA MOUNTED ON LH SIDE MIRROR		
810-027	ELECTRONIC MPH SPEEDOMETER WITH SECONDARY KPH SCALE, WITHOUT ODOMETER		
817-001	STANDARD VEHICLE SPEED SENSOR		

Prepared for:  
 Sheldon Seward  
 TEREX UTILITIES BB  
 500 OAKWOOD RD  
 WATERTOWN, SD 57201  
 Phone: 605-882-5515

Prepared by:  
 Truman Ingram  
 FOUR STAR FREIGHTLINER OF  
 MONTGOMERY  
 3140 HAYNEVILLE ROAD  
 MONTGOMERY, AL 36108  
 Phone: 334-263-1085

Data Code	Description	Weight Front	Weight Rear
812-001	ELECTRONIC 3000 RPM TACHOMETER		
162-011	IDLE LIMITER, ELECTRONIC ENGINE		
482-001	BW TRACTOR PROTECTION VALVE		
883-001	TRAILER HAND CONTROL BRAKE VALVE		
836-015	DIGITAL VOLTAGE DISPLAY INTEGRAL WITH DRIVER DISPLAY		
660-008	SINGLE ELECTRIC WINDSHIELD WIPER MOTOR WITH DELAY		
304-001	MARKER LIGHT SWITCH INTEGRAL WITH HEADLIGHT SWITCH		
882-004	TWO VALVE PARKING BRAKE SYSTEM WITH WARNING INDICATOR		
299-013	SELF CANCELING TURN SIGNAL SWITCH WITH DIMMER, WASHER/WIPER AND HAZARD IN HANDLE		
298-039	INTEGRAL ELECTRONIC TURN SIGNAL FLASHER WITH HAZARD LAMPS OVERRIDING STOP LAMPS		

### Design

065-000 PAINT: ONE SOLID COLOR

### Color

980-5F6 CAB COLOR A: L0006EY WHITE ELITE EY  
 986-020 BLACK, HIGH SOLIDS POLYURETHANE CHASSIS PAINT  
 962-972 POWDER WHITE (N0006EA) FRONT WHEELS/RIMS (PKWHT21, TKWHT21, W, TW)  
 966-972 POWDER WHITE (N0006EA) REAR WHEELS/RIMS (PKWHT21, TKWHT21, W, TW)  
 964-6Z7 BUMPER PAINT: FP24812 ARGENT SILVER DUPONT FLEX  
 963-003 STANDARD E COAT/UNDERCOATING

### Certification / Compliance

996-001 U.S. FMVSS CERTIFICATION, EXCEPT SALES CABS AND GLIDER KITS

### Raw Performance Data

AE8-99D CALCULATED EFFECTIVE BACK OF CAB TO REAR SUSPENSION C/L (CA) : 120.43 in  
 AM6-99D CALC'D SPACE AVAILABLE FOR DECKPLATE : 117.45 in

### Sales Programs

NO SALES PROGRAMS HAVE BEEN SELECTED



**Prepared for:**  
Sheldon Seward  
TEREX UTILITIES BB  
500 OAKWOOD RD  
WATERTOWN, SD 57201  
Phone: 605-882-5515

**Prepared by:**  
Truman Ingram  
FOUR STAR FREIGHTLINER OF  
MONTGOMERY  
3140 HAYNEVILLE ROAD  
MONTGOMERY, AL 36108  
Phone: 334-263-1085

## TOTAL VEHICLE SUMMARY

### Weight Summary

	<b>Weight Front</b>	<b>Weight Rear</b>	<b>Total Weight</b>
Factory Weight <sup>+</sup>	6401 lbs	4315 lbs	10716 lbs
<b>Total Weight<sup>+</sup></b>	<b>6401 lbs</b>	<b>4315 lbs</b>	<b>10716 lbs</b>

### Extended Warranty

**WAG-010 TOWING: 1 YEAR/UNLIMITED MILES/KM EXTENDED TOWING  
COVERAGE \$550 CAP FEX APPLIES (AT NO ADDITIONAL CHARGE)**

(+) Weights shown are estimates only.

If weight is critical, contact Customer Application Engineering.

(\*\*\*) All cost increases for major components (Engines, Transmissions, Axles, Front and Rear Tires) and government mandated requirements, tariffs, and raw material surcharges will be passed through and added to factory invoices.

## CAPITAL BUDGET FISCAL YEAR 2022

Part B

	Account Number	PROJECT DESCRIPTION	TOTAL COST FY2022	CITY FUNDS FY2022	2017 SPLOST	LOAN	OTHER	STWP
<b>General</b>								
1	350.6000.541300.000	Yarbrough House Renovation	100,000	100,000	0	0	0	17
2	350.6200.541200.000	City Limit Sign (Granite Stone and Landscape)	60,000	60,000	0	0	0	21
3	350.1500.117100.000	Strategic Land Acquisition	50,000	50,000	0	0	0	
4	350.1500.117100.001	Dried Indian Creek Greenway / Protective Corridor	1,000,000	250,000	0	0	750,000	a
5	350.4600.541400.510	Electric Vehicle Charging Stations	12,000	12,000	0	0	0	
6	350.1500.542200.000	City Manager Vehicle	30,000	30,000	0	0	0	
<b>Parks, Landscapes, and Recreation</b>								
7	350.6200.541200.001	Multi-Use Trails	300,000	300,000	0	0	0	
8	350.6200.542401.000	Asbury Street Park Wi-Fi	7,700	7,700	0	0	0	
<b>Streets, Sidewalks, and Street Lamps</b>								
9	350.4250.541200.000	Storm Drainage Plans & Improvements	20,000	20,000	0	0	0	
10	350.4200.541400.002	E. Clark Street Improvements	450,000	450,000	0	0	0	23,26
11	350.4226.541201.000	Whatcoat Street Improvements	300,000	300,000	0	0	0	9
12	350.4224.541203.002	City Sidewalk Project (Soule Street to North City Limits)	1,100,000	900,000	200,000	0	0	
13	350.4200.541201.000	Sidewalk Repairs and Planning	150,000	150,000	0	0	0	
14	350.4260.541400.000	Emory Street/Highway 81 Street Lamps	300,000	300,000	0	0	0	
15	350.4270.541400.000	Radar Speed Signs	10,000	10,000	0	0	0	
16	350.4270.541400.001	Speed Humps	5,000	5,000	0	0	0	
17	350.4200.541400.001	Street Repairs and Resurfacing	400,000	325,000	0	0	75,000	b
18	350.4200.542100.001	Streets Department - Lawnmower(s)	22,000	22,000	0	0	0	

## CAPITAL BUDGET FISCAL YEAR 2022

Part B

	Account Number	PROJECT DESCRIPTION	TOTAL COST FY2022	CITY FUNDS FY2022	2017 SPLOST	LOAN	OTHER	STWP
<b>Downtown Development Authority (DDA)</b>								
19	350.7550.612000.000	Downtown Development Authority	30,000	30,000	0	0	0	10,17,23
20	350.7550.521200.000	DDA - Professional Services	200,000	200,000	0	0	0	
<b>Electric Department</b>								
21	350.4600.541402.510	Electric System Improvements	269,563	269,563	0	0	0	
22	350.4600.542200.002	Line Truck	203,871	203,871	0	0	0	
<b>Water and Sewer Department</b>								
		Water Line Replacement						
23	350.4400.541000.505	Queen Ann, W. Bonnell, Stone Streets	200,000	200,000	0	0	0	
24	350.4400.541001.505	Oxford Rd, Keel Street, Perry Circle	1,330,000	580,000	0	0	750,000	c
25	350.4300.542100.505	Sewer Camera and Locator	7,365	7,365	0	0	0	
<b>Police Department</b>								
26	322.3200.542201.000	Equipment - Police Vehicles	50,000	0	50,000	0	0	
27	322.3200.542501.000	Equipment - Police Radios	44,100	0	44,100	0	0	
<b>TOTALS</b>			<b>6,651,599</b>	<b>4,782,499</b>	<b>294,100</b>	<b>0</b>	<b>1,575,000</b>	

Footnotes:

- a Funds from the Georgia Outdoor Stewardship Program (GOSP).
- b Funds from the Local Maintenance Improvement Grant (LMIG).
- c Funds from the Community Development Block Grant (CBDG).

## Marcia Brooks

---

**From:** Karl Lee <kjgrllc@icloud.com>  
**Sent:** Tuesday, August 31, 2021 9:43 AM  
**To:** Marcia Brooks  
**Subject:** Re: KJGRLLC

LeafBlaster Pro

> On Aug 31, 2021, at 9:03 AM, Marcia Brooks <mbrooks@oxfordgeorgia.org> wrote:

>  
> Good morning Mr. Lee,  
> Our mayor is asking about the product that would be installed with this quote. Can you provide me the name of the product? Thanks.

>  
> -----Original Message-----  
> From: Karl Lee <kjgrllc@icloud.com>  
> Sent: Monday, August 30, 2021 4:00 PM  
> To: Marcia Brooks <mbrooks@oxfordgeorgia.org>  
> Subject: Re: KJGRLLC

>  
> Yes, Those items are included at no additional charge.

>  
> Sent from my iPhone

>> On Aug 30, 2021, at 2:59 PM, Marcia Brooks <mbrooks@oxfordgeorgia.org> wrote:

>>  
>> Good afternoon Mr. Lee,  
>> Thank you for this information. Another vendor provided a quote that includes the following, and I just wanted to see if this quote includes these items, or if the cost for these items would be additional if provided by your company.

>>  
>> The items are:  
>> 1. Realign gutters for proper draining, if needed.  
>> 2. Install hidden brackets for additional support on your gutter system.

>>  
>> Thanks very much.

>>  
>> Marcia Brooks  
>> City Clerk/Treasurer  
>> City of Oxford  
>> 110 West Clark Street  
>> Oxford, Georgia 30054  
>> Phone: 770-786-7004  
>> FAX: 770-786-2211

>>  
>>  
>>  
>> -----Original Message-----  
>> From: Karl Lee <kjgrllc@icloud.com>

>> Sent: Monday, August 30, 2021 10:49 AM  
>> To: Marcia Brooks <mbrooks@oxfordgeorgia.org>  
>> Subject: KJGRLLC

>>  
>> Marcia,

>> We at KJGRLLC would like to thank you for giving us the opportunity to earn your business. We don't take it for granted because without customers like you, we would not exist. We relish the opportunity to give you a permanent solution for your water issues.

>> Marcia, if you decide to move forward with KJGRLLC completing your project, we will perform the following:  
>> • Clean out your existing gutters and downspouts •Seal your gutters with a 50 year tri-polymer •Install approximately 598 feet of 7" gutter protection, stainless steel.

>> This includes a manufacturer limited lifetime replacement guarantee. We guarantee that your gutters will not clog, rust or erode.

>> You will get a lifetime warranty on our workmanship. This is a permanent solution.

>> The price includes all taxes, insurance during installation and all clean up.

>> Contract price: \$5400

>>  
>> We look forward to taking care of your project.

>> If you have any questions don't hesitate to contact me: 470-292-6686

>>  
>>



**Karl Lee**  
VP of Marketing  
770-653-3544



<http://kjgrllc.com>



**KJGR LLC.**

Water Displacement Specialists

3011 Rainbow Dr.  
Suite 101  
Decatur, GA 30034

FREE ESTIMATE



**HomeCraft™**

500 Plantation Park Dr,  
Loganville, GA 30052

NGA Marketing Manager  
Tyler Isbell (706) 391-3416  
Matt Davis (865) 469-8676  
For Warranty Service Call: 678-227-2506

(Call Monday- Friday, 9:00 am until 5.00 pm EST)

**THIS AGREEMENT**, made and entered between Marcia Brooks, (OWNER) and HomeCraft™ (CONTRACTOR), who agrees to furnish all labor and materials necessary to perform the work hereinafter on the premises of the owner located at 110 W Clark Street, in the City of Oxford State of GA Zip 30054

Phone # (770) 786-7004 Alternate Phone # \_\_\_\_\_

Email Address: mbrooks@oxfordgeorgia.org

YES  NO  We are installing approximately 8 feet of 8 inch gutter on your home, color is \_\_\_\_\_

YES  NO  We are installing approximately 8 feet of 8 downspout on your home, color is \_\_\_\_\_

YES  NO  We are installing approximately 636 feet of the 7 inch gutter protection on your home.

YES  NO  We are installing approximately 0 feet of drip edge on your home.

YES  NO  We are replacing approximately 8 feet of 8 fascia on your home. (fascia will be primed white)

YES  NO  We are replacing approximately 8 square feet of soffit on your home. (soffit will not be painted)

YES  NO  We seal your gutters with a 50 year tri-polymer.

YES  NO  We realign the gutters for proper drainage, if needed.

YES  NO  We install hidden brackets for additional support on your gutter system.

YES  NO  We will clean out your existing gutters and downspouts.

YES  NO  You get a manufacturer limited lifetime replacement guarantee.

YES  NO  Price includes all taxes, insurance during installation and all clean up.

Notes: "7" inch special order protection

Payment Terms: In consideration of the labor, materials and repair, if any, furnished by said contractor, the Owner agrees to pay to the contractor.

Contract price, including tax \$ 7500.00

Installation Date: \_\_\_\_\_

Deposit(Non-Refundable) \$ 0

Pay Terms: check

Unpaid Balance \$ 7500.00

Job # : \_\_\_\_\_

- A. It is hereby understood and agreed that the unpaid balance of cash price or the bank completion certificate must be paid to the seller's installer at the time the work is completed.
- B. Installation is subject to production scheduling, weather conditions and related factors. The contractor shall furnish materials for the work and complete the work to be done in a substantial and professional manner. All workmanship is guaranteed for one (1) calendar year starting at the time of installation. Service calls after one (1) year will be subject to a service charge. Purchaser agrees that HomeCraft™ will not refund any money after the product has been installed.
- C. You, the buyer, may cancel this Agreement of purchase by mailing a written notice to the seller post-marked not later than the third business day after the date this Agreement was signed. It is agreed that if the Owner cancels this contract AFTER THREE (3) DAYS from date of acceptance and before commencement of work, through no fault of the Contractor, The Owner agrees to pay 25% of the contract price or the cost of the materials purchased by the Contractor to the date of cancellation, whichever is greater.

IN WITNESS WHEREOF, the Owner and Contractor have caused these present to be signed this:

Month August, Day 26, Year 2021

Notice to Owner: Do not sign this contract if blank.

[Signature]  
Sales Representative

\_\_\_\_\_  
Owner

\_\_\_\_\_  
Owner



# Your Investment with LeafFilter® Includes the Following:



- ✓ We completely clean out your existing gutters and downspouts.
- ✓ We then seal your gutters and downspouts with 50 year silicone.
- ✓ We repair any damaged gutters and/or downspouts, if necessary.
- ✓ We re-align the gutters, if necessary.
- ✓ We install hidden brackets in the gutter for reinforcement.
- ✓ We install the LeafFilter gutter protection system on the home.
- ✓ We give you a lifetime transferable warranty.
- ✓ We give you a manufacturer's money back, no clog, guarantee.
- ✓ Price includes taxes, insurance during installation and all clean up.

## TOTAL INVESTMENT

588' 7" LEAF FILTER

\$ 10,164

License# 7656  
License# 41354  
License# 50145  
License# 99338  
License# 128344  
License# 218294

License# 2102212986  
License# 2106212946  
License# 603 233 977  
License# 2705132153A  
License# LEAFFNW822JZ  
License# WC-29998-H17

License# WV056912  
Nassau HIC License# H01067000  
Suffolk HIC License# 52229-H  
Registration# 176447  
Registration# 366920918  
Registration# 13VH09953900

Registration# C127229  
Registration# C127230  
Registration# HIC.0649905  
Registration# IR731804  
Registration# PC6475  
Registration# PA069383

CSLB# 1035795  
DOPL# 10783658-5501



110 W. Clark Street  
Oxford, GA 30054  
Phone 770-786-7004  
Fax 770-786-2211  
www.oxfordgeorgia.org



Incorporated December 23, 1839

Mayor David S. Eady  
City Manager Bill Andrew  
City Clerk Marcia Brooks

October 4, 2021

Mr. Burke Walker, Executive Director  
Northeast Georgia Regional Commission  
305 Research Drive  
Athens, GA 30605-2795

**RE: City of Oxford State Fiscal Recovery Fund Application**

Dear Mr. Walker:

I am writing to request the assistance of the Northeast Georgia Regional Commission (NEGRC) with the preparation of an application for State Fiscal Recovery Funding, due October 31, 2021. Specifically, the NEGRC will work with the City of Oxford to prepare an application for a water infrastructure improvement project.

Specifically, we plan to use these funds to largely complete the water line replacement effort not funded by the FY 2021 CDBG award. The primary contact for this request is Bill Andrew, City Manager and he may be reached at (770) 786-7004 or [bandrew@oxfordgeorgia.org](mailto:bandrew@oxfordgeorgia.org).

Thank you for your time and attention with this request. We look forward to working with your team.

Sincerely,

David Eady, Mayor

**City of Oxford**  
**Invoices >=\$1,000**  
**Paid in September 2021**

VENDOR	DESCRIPTION	AMOUNT
<b>RECURRING CHARGES</b>		
City of Oxford Utilities	July-August services	2,670.06
Newton County Water & Sewerage Authority	Sewer Treatment Fees, 7/29/2021 – 8/30/2021	6,319.33
Georgia Municipal Association	GMEBS Life and Health Insurance Billing for September 2021; Invoice #315446 GMEBS Life and Health Insurance Billing for October 2021; Invoice #315446	9,482.78
Georgia Municipal Association	GMEBS Retirement Trust Fund Employer Contributions September 2021	5,991.59
Georgia Environmental Finance Authority (GEFA)	Monthly Payment on Loan 2016L06WQ September 2021	4,556.05
Southeastern Power Administration (SPA)	SEPA Energy Cost (August 2021) Inv. #B-21-2805	3,017.50
Municipal Electric Authority of Georgia (MEAG)	Monthly Electric Purchases for August 2021	132,856.48
Electric Cities of Georgia	Consulting and planning services for September 2021	5,087.00
IRS	Federal Payroll Taxes, September 2021	14,338.16
AT&T	Monthly service August 13-September 12	1,221.14
Phoenix Personnel, LLC	Maintenance temp workers, week ending 8/22/2021 - \$1,091.30 Maintenance temp workers, week ending 8/29/2021 - \$1,257.20 Maintenance temp workers, week ending 9/19/2021 - \$1,224.30	3,572.80
Latham Home Sanitation	Commercial Waste Removal Services August 2021	7,361.18
VC3, Inc. (formerly Sophicity)	September charges for software and hardware support; invoice #65259	2,199.81

VENDOR	DESCRIPTION	AMOUNT
<b>PURCHASES/ CONTRACT LABOR</b>		
C. David Strickland, P.C.	August 2021 professional legal services	1,485.00
McNair, McLemore Middlebrooks & Co.	August 2021 professional financial services – audit prep	6,000.00
Stephen A. Hathorn, P.C.	Legal services – Municipal Court Judge – July-September 2021	1,250.00
Freeman Law Firm	Legal services – Municipal Court Solicitor – January – June 2021	3,100.00
Georgia Correctional Industries	Desk, credenza and hutch for City Clerk’s office	2,305.00
Monroe Power Equipment Co., Inc.	Purchase of new lawn mower authorized in FY2022 Capital Budget and approved by City Council on 9/7/2021	10,941.00
HCS Services, LLC	Repair water main breaks on Queen Ann Street and Richardson Street and replace 2”water meter at 55 Business Parkway on 8/23/2021	2,900.00
Scarborough Tree, Inc.	Removal of fallen tree on Hwy. 81 at Oxford Baptist Church 8/18/2021	1,200.00
Gresco	Supplies/materials for temporary housing at Oxford College – will be reimbursed	7,534.55
Burford’s Tree, LLC	FY 2021 Powerline tree trimming – week ending 7/3/2021 and 7/10/2021	5,690.00
Keck & Wood	Professional services – preliminary plan layout for Emory Street Sidewalks (North) project	10,150.00